

THREE PHASE CONVERTOR TYPES 545, 546, 547 & 548

PRODUCT MANUAL HA049975

WARNING

NEVER WORK ON THE CONTROLLER, MOTOR,  
OR ANCILLIARY EQUIPMENT WITHOUT FIRST  
ISOLATING ALL SUPPLIES TO THE SYSTEM.

CONTROLLER WARRANTY

For further details on SSD Controller Warranty and Repair refer to the Standard Conditions of Sale IA058393C.

COPYRIGHT in this document is reserved to SSD Ltd.

## CONTENTS

<u>SECTION</u>	<u>PAGE</u>
INTRODUCTION	5
TECHNICAL DETAILS	6
PRODUCT CODE	8
INSTALLATION AND WIRING:	
A. Installation	10
B. Ventilation and Cooling	10
C. Basic Wiring Instructions	10
D. Notes on Wiring	11
Basic Wiring and Installation Details - 545 & 546	12
- 547 & 548	14
CONTROLLER TERMINAL DESCRIPTIONS:	
Terminal Block A	18
Terminal Block B	19
Terminal Block C	20
Terminal Block D	22
BLOCK DIAGRAM DESCRIPTION:	
A. Power Configuration	23
B. The Control Operation	23
C. Start and Stop Sequencing	25
Block Diagram - 4 Quadrant - 545 & 547	27
- 2 Quadrant - 546 & 548	28
SETTING UP AND OPERATING INSTRUCTIONS:	
A. Before Attempting to Connect Power	29
B. Preparation	29
C. Checking The Drive and Setting-Up	30
D. Running Performance Adjustments	32
DIAGNOSTIC TEST FACILITIES:	
A. Description of Diagnostic Test Unit	35
B. Diagnostic Test Procedure	35
C. Connection and Disconnection of the Diagnostic Test Unit	35
Chart 1. Drive Condition Indicators - Description	36
2. Drive Condition Indicators - Status Recognition	
- Stop Condition	37
- Start Condition	38
3. Diagnostic Test Unit - Voltage Measurements	40
SPARE PART IDENTIFICATION LIST:	
Printed Circuit Boards	44
Fuses	44
Semiconductors	45
Miscellaneous	46
Recommended Minimum Spares Holding	46
SERVICE INFORMATION:	
Power Circuit Configuration - 545	47
- 546	48
- 547	49
- 548	50
Sales and Service Address List	51

## INTRODUCTION

All members of the 540 Series of Armature and Field Weakening Controllers accept standard supply voltages in the range 110 to 480 Volts A.C. and provide controlled D.C. output voltages and currents, suitable for powering D.C. Shunt Field motors of up to 200HP (150Kw) rating. The motor Armature Controllers include both regenerative and non-regenerative models.

Non-regenerative Controllers consist of a fully-controlled Thyristor bridge with full transient and overload protection, together with its associated electronic control circuitry and provide accurate speed and/or torque control in one direction of rotation.

Regenerative Controllers consist of two fully-controlled, fully protected Thyristor bridges together with a sophisticated electronic control system and provide full four-quadrant control i.e. controlled acceleration and deceleration, speed and torque in both directions of rotation.

All models of Armature Controller offer a fixed D.C. supply for Field excitation, some applications however require an extended speed or constant horsepower range of control. For these applications the 540 series includes a Field Weakening Controller. This consists of a half-controlled single phase Thyristor bridge with full transient and overload protection, together with its associated electronic control circuitry.

In all members of the 540 series the control circuitry is totally isolated from the power circuitry, thus simplifying the interconnection of controllers within a system and improving operator safety. The control circuitry adjusts automatically to accept supply frequencies in the range 45-65 Hz and possess high immunity to mains bourne interface. Those Armature Controllers which employ three phase Main supplies are phase rotation insensitive.

Other standard facilities of the Armature Controllers include Field failure, overtemperature, fuse failure, line and synchronisation loss alarms. The Field Weakening Controllers possess a similar range of protection including Armature over-voltage and Tacho failure/reversal alarms. All Controllers provide external customer enable/inhibit inputs for safety interlocks etc.

All units of the range are designed for simple and economical panel mounting using keyhole slots. If it is necessary to remove the controller from the panel, disconnection and reconnection is simplified by plug-in control and auxiliary power connections, leaving only the Main supply, Earth and Armature connections to be made by screw connector.

Standardisation of parts, wherever possible throughout the range reduces the variety of spare parts required to

maintain a multi-drive system. For example, the same basic control and power supply PCB's are used in all types of three phase Armature controller.

Commissioning and the location of faults (both within the controller and external to it) are greatly assisted by built in Condition Indicators which show the status of the various system alarms. Further assistance is available by use of the optional Diagnostic Test unit type 5570 which provides access to 27 alarms, inputs and principal circuit nodes throughout the Controller. This unit, which is available as a portable hand-held instrument (or in some cases as an on-board facility), also has output sockets for the connection of an oscilloscope, chart recorder or other instruments.

Briefly, the 540 family is as follows:-

- 540 - Single phase (Line to Neutral or Line to Line), regenerative, four quadrant Armature Controller. For currents up to 35A.
- 541 - As for the 540 but two quadrant, non-regenerative control.
- 545 - Three phase, regenerative, four quadrant Armature Controller. For currents up to 180A, those rated above 110A being fan force ventilated.
- 546 - Identical to the 545 but two quadrant, non-regenerative control only.
- 547 - Three phase, regenerative, four quadrant Armature Controller. For currents up to 350A, all units force ventilated.
- 548 - Identical to the 547 but two quadrant, non-regenerative control only.
- 5401 - Single phase (Line to Neutral or Line to Line). Field Weakening Controller for full strength field currents up to 20A.

In addition to those facilities already mentioned, a comprehensive range of options and auxiliary equipment are available for use with all SSD Controllers to allow, for example, the following modes of control:-

- Contactor reversing
- Dynamic braking
- Multi-drive programming
- Programmable process control
- Tension/torque contour control
- Etc....



**MECHANICAL DETAILS**

545 & 546 Convertors:

Mounting Centres:	Vertical - 425mm (or 16.25" GPO rack pitch).	
	Horizontal - 190mm (7.48").	
	<u>Ratings up to 150A</u>	<u>Ratings from 150.1 to 180A</u>
Overall Width:	241mm (9.49")	241mm (9.49")
Overall Height:	445mm (17.52")	560mm (22.05")
Overall Depth:	205mm (8.07")	215mm (8.46")
Weight:	10Kg - 13Kg (22lb - 28.7lb)	14.6Kg (32.2lb)
Minimum Airflow Clearance:	90mm above 90mm below	150mm above 100mm below
Nominal Blower Throughput:	100m <sup>3</sup> /Hour (where fitted)	300m <sup>3</sup> /Hour
Control Terminations:	Plug-on connectors (with retaining catches).	
Power Terminations:	Bus-bars with 8mm screws and captive nuts.	
Access:	Hinge-down / lift-off overall cover. Hinge-down Control Printed Circuit Board (with its own independent covers).	
Storage Temperature and Conditions:	-20°C - +50°C short term (100 hours). 0°C - +50°C long term. Protect from direct sunlight. Ensure dry, corrosive free environment.	

547 & 548 Convertors:

Mounting Centres:	Vertical - 578mm (or 22.75" GPO rack pitch).
	Horizontal - 190mm (7.48").
Overall Width:	290mm (10.4").
Overall Height:	685mm (26.97").
Overall Depth:	280mm (11.2").
Weight:	28kg (66lbs).
Airflow Clearance:	150mm minimum above and 100mm minimum below
Nominal Blower Throughput:	230m <sup>3</sup> /Hour.
Control Terminations:	Plug-on connectors (with retaining catches).
Power Terminations:	Bus-bars with 10mm screws and captive nuts.
Access:	Hinge-down / lift-off Control Circuit cover. Hinge-up / lift-off Fuse and Line Terminal cover. Hinge-down Control Printed Circuit Board (with its own independent covers).

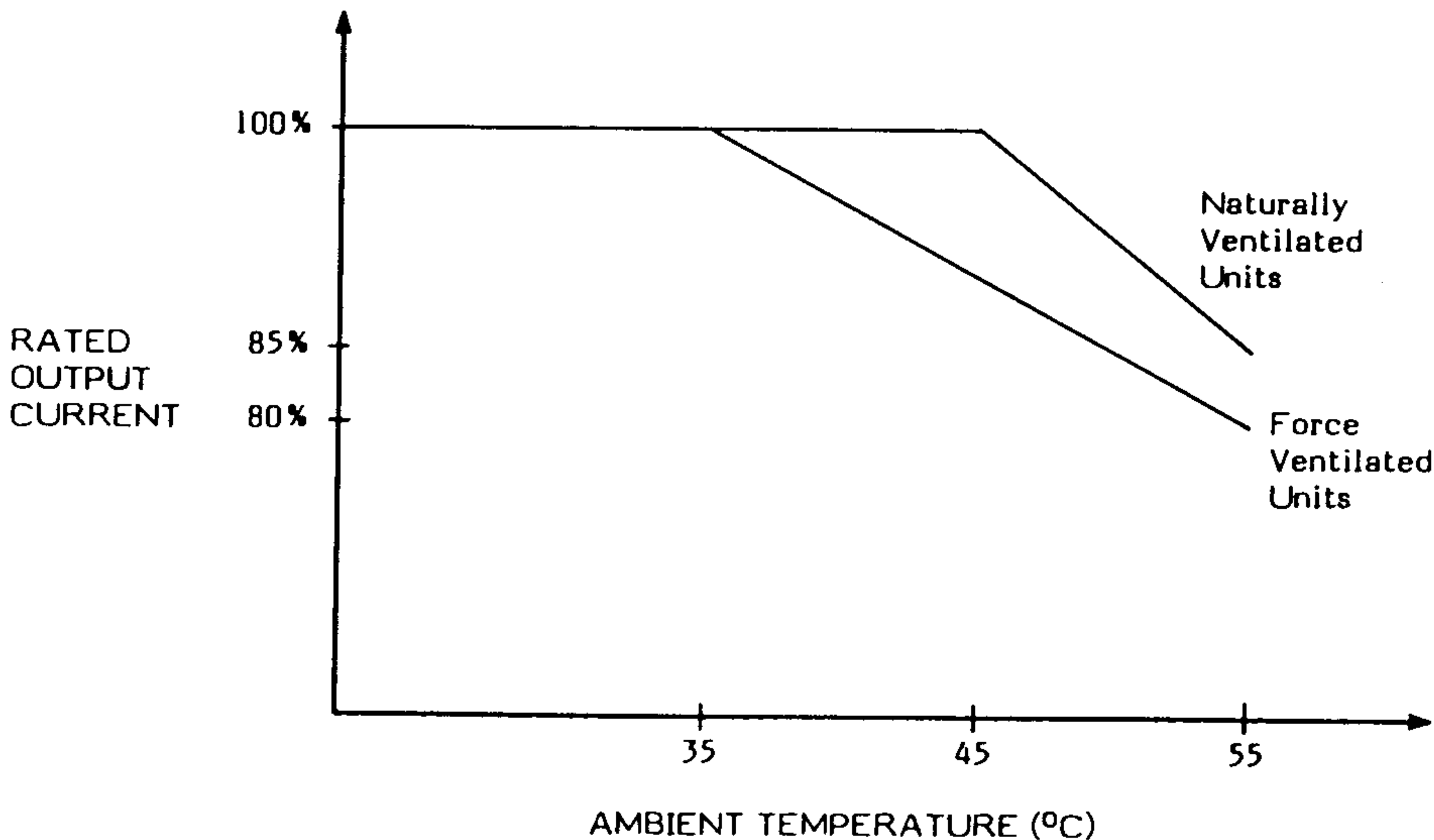

DERATING CURVES

Altitude Derating: Derate linearly above 500 metres at 5% per 1000 metres up to 5000 metres.

## PRODUCT CODE

Three phase convertors, types 545, 546, 547 and 548.

All members of the three phase convertor range can be fully specified using a 20 digit numerical order code. This Product Code appears as the "Model No." on the convertor rating label, an example of which is shown overleaf.

A rating label is attached to each convertor - on the inner surface of the right hand side panel, or on the top cross-member - always check that all specified parameters are correct.

The 20 digits are split into 9 groups or blocks. The function and number of digits in each block is given below:

BLOCK NO.	NO. OF DIGITS	FUNCTION
1	3	Basic product.
2	4	Output current.
3	1	Input power voltage.
4	1	Field convertor configuration.
5	1	Input auxiliary supply voltage.
6	3	Speed feedback calibration.
7	4	Option switch settings.
8	1	Diagnostic option.
9	2	Special options.

The 9 blocks are defined as follows:

**Block 1:** 3 digits identifying the basic product.

- 545 - 3-Phase, 4 Quadrant (regenerative) convertor ) Up to 180A
- 546 - 3-Phase, 2 Quadrant (non-regenerative) convertor )
- 547 - 3-Phase, 4 Quadrant (regenerative) convertor ) 180A to 350A
- 548 - 3-Phase, 2 Quadrant (non-regenerative) convertor )

**Block 2:** 4 digits identifying the DC output current rating.

The digits in this block represent a number between 000.0 and 999.9. To form the code from the numbers, the decimal point is suppressed and leading zeros are added where necessary.

Examples: 234.5 AMPERES = CODE 2345  
 87.6 AMPERES = 087.6A  
 = CODE 0876

Conversely: CODE 0470 = 47.0 AMPERES  
 CODE 1234 = 123.4 AMPERES

**Block 3:** 1 digit identifying the 3-Phase AC power voltage.

0	1	2	3	4	5	
110v	115v	208v	220v	240v	380v	
			6	7	8	9
			415v	440v	460v	480v

**Block 4:** 1 digit identifying field supply configuration.

- 0 - Externally supplied full-wave rectifier. "Field fail" plug fitted in the "Override" position.
- 1 - Internally supplied field regulator.
- 2 - Internally supplied full-wave rectifier.
- 3 - Internally supplied half-wave rectifier.
- 4 - Externally supplied field regulator.
- 5 - Externally supplied full-wave rectifier.
- 6 - Externally supplied half-wave rectifier.

**Block 5:** 1 digit identifying the control supply voltage (AC).

0	1	2	3	4
110v	115v	208v	220v	240v

**Block 6:** 3 digits identifying the tachogenerator feedback voltage at full speed.

The three digits in this block form a number between 010 and 999 which represents the actual tacho feedback voltage, rounded to the nearest whole number and with leading zeros added where necessary.

- For example: 123 VOLTS = CODE 123
- 45.6 VOLTS = CODE 046
- or conversely: CODE 090 = 90 VOLTS ±0.5V
- CODE 180 = 180 VOLTS ±0.5V

**Block 7:** 4 binary digits identifying the setting of the four internal option switches.

Each digit defines the setting of one switch and can take the value 0 (= OFF) or 1 (= ON) as follows:

- . . . . . First digit, switch 1:
  - . 0 = OFF - Armature current meter reads modulus.
  - . 1 = ON - Armature current meter reads ±.
- . . . . . Second digit, switch 2:
  - . 0 = OFF - Standstill logic disabled.
  - . 1 = ON - Standstill logic enabled.
- . . . . . Third digit, switch 3:
  - X X X X 0 = OFF - Setpoint ramp disconnected.
  - . 1 = ON - Setpoint ramp connected.
- . . . . . Fourth digit, switch 4:
  - 0 = OFF - Setpoint ramp rate 2.5 to 75 seconds.
  - 1 = ON - Setpoint ramp rate 0.25 to 7.5 seconds.

**Block 8:** 1 digit identifying the On-board diagnostic option.

- 0 - On-board diagnostic unit not fitted.
- 1 - On-board diagnostic unit fitted.

**Block 9:** 2 digits identifying special options.

- 00 - No special options.
- 01 to 98 - Documented special options.
- 99 - Undocumented special options; specify requirement.

PRODUCT CODE EXAMPLE

In all communications please quote the full Model No. (Product Code) and Serial No. both of which contain important product information. An explanation of a typical Product Code is shown below.

<b>Input Supplies</b>	Power Field(int/ext) Auxiliary	V 50-60Hz V 50-60Hz V 50-60Hz	<b>Motor Connections</b> GA047080U001	Armature Feedback signal at max speed (tacho/armature isolator)	A. Field	A max.
Model No	545-0837-6-2-4-120-1101-1-00			<b>ALWAYS check model number and rating</b>		
Serial No	Made in England by SSD Ltd., Littlehampton. Telex 87142					

	545	-	0837	-	6	-	2	-	4	-	120	-	1011	-	1	-	00
	.	.	.	.	.	.	.	.	.	.	.	.	.	.	.	.	.
	BLOCK	.	.	.	.	.	.	.	.	.	.	.	.	.	.	.	.
Convertor Type = 545	1	.	.	.	.	.	.	.	.	.	.	.	.	.	.	.	.
			BLOCK	.	.	.	.	.	.	.	.	.	.	.	.	.	.
Armature Current = 83.7A			2	.	.	.	.	.	.	.	.	.	.	.	.	.	.
					BLOCK	.	.	.	.	.	.	.	.	.	.	.	.
3-Phase supply = 415v Voltage					3	.	.	.	.	.	.	.	.	.	.	.	.
							BLOCK	.	.	.	.	.	.	.	.	.	.
Internally supplied Full-Wave field							4	.	.	.	.	.	.	.	.	.	.
									BLOCK	.	.	.	.	.	.	.	.
Auxiliary Supply = 240v Voltage									5	.	.	.	.	.	.	.	.
											BLOCK	.	.	.	.	.	.
Speed Feedback = 120v											6	.	.	.	.	.	.
													BLOCK	.	.	.	.
Option Switches: S1-ON S2-OFF, S3-ON, S4-ON														7	.	.	.
																BLOCK	.
On-Board diagnostic Unit Fitted																8	.
																	BLOCK
No Special Options																	9



## BASIC INSTALLATION AND WIRING INSTRUCTIONS

### A. INSTALLATION

The 540 series motor control units are all designed to mount directly onto a flat surface. They should be fastened by means of 6mm (1/4") bolts or screws through the fixing points at each corner (8mm or 5/16" in the case of 547 and 548 units). These points are in the form of keyholes and slots to simplify fastening or removal.

Please see the relevant installation drawing of this manual for overall dimensions and positions of fixing holes.

NOTE:(i)(a) The vertical height of the fixing centres is compatible with International 19" Standard Cabinet mounting dimensions.

(b) With the exception of 547 and 548 units it is possible to mount two drives side by side in the 19" width of these cabinets.

(ii) The overall dimensions are also convenient for use in Standard NEMA Enclosures.

### B. VENTILATION AND COOLING

In normal operation the drive unit needs to dissipate heat and must, therefore, be mounted to permit the free flow of cool air vertically through the circuit board area and over the fuses and heat sink area at the back.

The normal maximum ambient operating temperatures are:

Naturally ventilated unit: 45°C (113°F)

Fan-force cooled units: 35°C (95°F).

For operation above these limits derating of the controller may be necessary, refer to the electrical specification within this manual.

Care should be taken to ensure that the mounting surface is also cool and that any heat generated by adjacent equipment is not transmitted to the drive unit.

As a general rule allow about 6" (150mm) of clear space above and below the drive for free air flow.

### C. BASIC WIRING INSTRUCTIONS

The following set of instructions is a description of the wiring requirements for operation as a basic speed controller and should be read in conjunction with the correct wiring diagram. The complexity of drive applications precludes the inclusion of diagrams showing all options, but any drive with specific options requested at order stage will be supplied with its appropriate wiring diagrams, which will supersede the diagrams listed below:

<u>Controller Type</u>	<u>Wiring Diagram Number</u>
540 & 541	HJ047176
545 & 546	HJ047940
547 & 548	HJ049197

D.C. shunt motors vary in the complexity and identification of their terminals. If in doubt, check with SSD - incorrect wiring to motors is a common commissioning problem.

To avoid damaging the drive, never carry out high voltage resistance checks on the wiring without first completely disconnecting the drive from the circuit being tested.

1. Power cables must have a minimum rating of 1.5 x full load current.
2. Control wiring must have minimum cross-section of 1.5 sq.mm. for robustness, (0.75 sq.mm. minimum within the drive enclosure).
3. All incoming main power supply connections should be separately protected by the correct HRC fuses.
4. A substantial ground or earth connection should be made to the Earth terminal of the drive.
5. The main contactor should be operated by connecting the coil to terminals D12 (Line) and D11 (Neutral). If the coil inrush current on "switch on" is likely to exceed 4 Amps a suitable slave relay must be used.
6. The auxiliary or control Power Supply (single phase 50/60Hz) should be connected to terminals D10 (Neutral) and D9 (Line) with the appropriate external fuse protection. Check that the transformer tapping on the internal Power Supply printed circuit board is connected to the correct voltage.
7. Connect the motor field(-) to terminal D8 and field(+) to terminal D5. If the drive is used with a permanent magnet field motor, or if the field is excited externally, it will be necessary to override the internal field failure protection circuits. This is achieved by moving the connector marked "Field Fail" on the Power Supply printed circuit board to the "Override" position.
8. The type of field connection for which the controller was built is indicated in the model number code, Block 4. If the code is 1, 2 or 3 the A.C. supply to the field rectifier is derived from within the controller. However if the Block 4 code is 4, 5 or 6 then the correct A.C. supply must be provided at terminals D1 and D4. Special high speed fuses for the A.C. supply to the field rectifier are mounted on the Power Supply printed circuit board. Plug-on wire connections from those fuses are used to select Internal or External field A.C. supply. Thus if necessary the type of field supply connection can be altered from that indicated in the Block 4 code as follows:-

(i) For External A.C. supply connect to the two pins marked "field supply-internal" or "FE".

(ii) For Internal A.C. supply from incoming phase connections L1 and L2, connect these wires to the two pins marked "field supply-internal" or "FI".

9. The main power supply is connected to bus bar terminals L1, L2, L3 (L1, L2 in the case of 540 and 541 units). These connections should be made via the correct rated HRC fuses and the normally open contacts of the main contactor.
10. The motor armature should be connected to bus bar terminals A(+) and A(-) (this circuit should be protected by a D.C. rated fuse or D.C. circuit breaker if high energy motor loads are present. If in doubt, consult SSD Engineering Department).
11. For normal operation the speed demand signal is connected to the "Setpoint Ramp Input" terminal A4. This input is scaled so that:-

+10V input = forward speed demand.

-10V input = reverse speed demand.

This  $\pm 10\text{v}$  demand signal can be generated easily from an external potentiometer with its ends connected to the +10V Reference (terminal A11) and the -10V Reference (terminal A12). For non-reversing applications and 2 quadrant controllers 541, 546 & 548 the setpoint input signal only needs to vary from 0 to +10 Volts. Terminal A1 should be used for the 0 Volt connection to the setpoint potentiometer in this case. The setpoint potentiometer should be between 2K and 10K ohms in value. All connections to the setpoint circuit should be by means of screened cable. The screen should be grounded or earthed ONLY AT THE MOTOR CONTROLLER END.

12. The tachogenerator speed feedback signal should be connected with negative to 0v terminal B1 and positive to tacho input terminal B2, (for forward motor rotation). It is important that this signal cable is screened over its entire length. The screen should be grounded or earthed ONLY AT THE MOTOR CONTROLLER END. Any other grounding arrangement may cause problems.
13. The Main Current Limit is adjustable by means of potentiometer P7 (under the front cover of the controller). For normal operation the Main Current Limit terminal B8 should be connected to the +10V Reference terminal B9. This gives adjustment on P7 of 0 to 200% full load current. If external control of Main Current Limit is required, this is achieved by applying a variable voltage to terminal B8 so that 0 to 10 Volts gives 0 to 200% F.L.C. (when potentiometer P7 turned fully clockwise).
14. Motor Over Temperature sensing devices, such as thermostats, microtherms or P.T.C. thermistors should be connected (in series if more than one) to terminals C1 and C2. If over temperature protection is not required, terminals C1 and C2 must be linked to allow the drive to run.
15. The Enable and Auxiliary Enable terminals C5 and C3 must be connected to C4 in order that the drive may run. However, external normally closed

interlock contacts may be connected in series with C3. Interruption of the supply to terminal C3 will disable the drive and the Ready and Drive Operational outputs.

#### NOTE:

The Thermistor/microtherm and Field failure alarms normally disable the drive only while a fault exists; if the fault clears, because the motor cools down for example, the motor will restart automatically. However, these alarms can be made to latch the drive in the disabled state indefinitely by connecting C3 to C10 instead of C4 (any external interlock contacts connected in the C3 to C10 link will also be latched in this manner). In this mode a Thermistor/microtherm, Field failure or external interlock alarm condition can only be cleared, and the motor restarted, by operating the start/stop controls.

16. Stop/Start control is normally provided either from two momentary contacts or from a single holding contact.

#### (i) Momentary contacts:-

Connect normally closed STOP contact between terminals C4 and C6.

Connect normally open START contact between terminals C6 and C7.

**NOTE:** Additional STOP push-buttons should have normally closed contacts and should be wired in series with main STOP push-buttons between terminals C4 and C6

#### (ii) Single holding contact:

Connect between terminals C4 and C7

Open contact to STOP.

Close contact to START.

### D. NOTES ON WIRING

1. The spare terminals of Terminal Block D provide additional isolation between adjacent high voltage terminals. They must not be used as interconnection points for any power or control wiring.
2. Indicator lamps, annunciators etc, for "Drive On" condition should be switched by an auxiliary contact of the main contactor - not by the controller internal relay.
3. All connections made to Terminal Blocks A,B and C MUST BE ISOLATED VOLTAGES.
4. To avoid damaging the drive, never carry out high voltage resistant checks on the wiring without first completely disconnecting the drive from the circuit being tested.

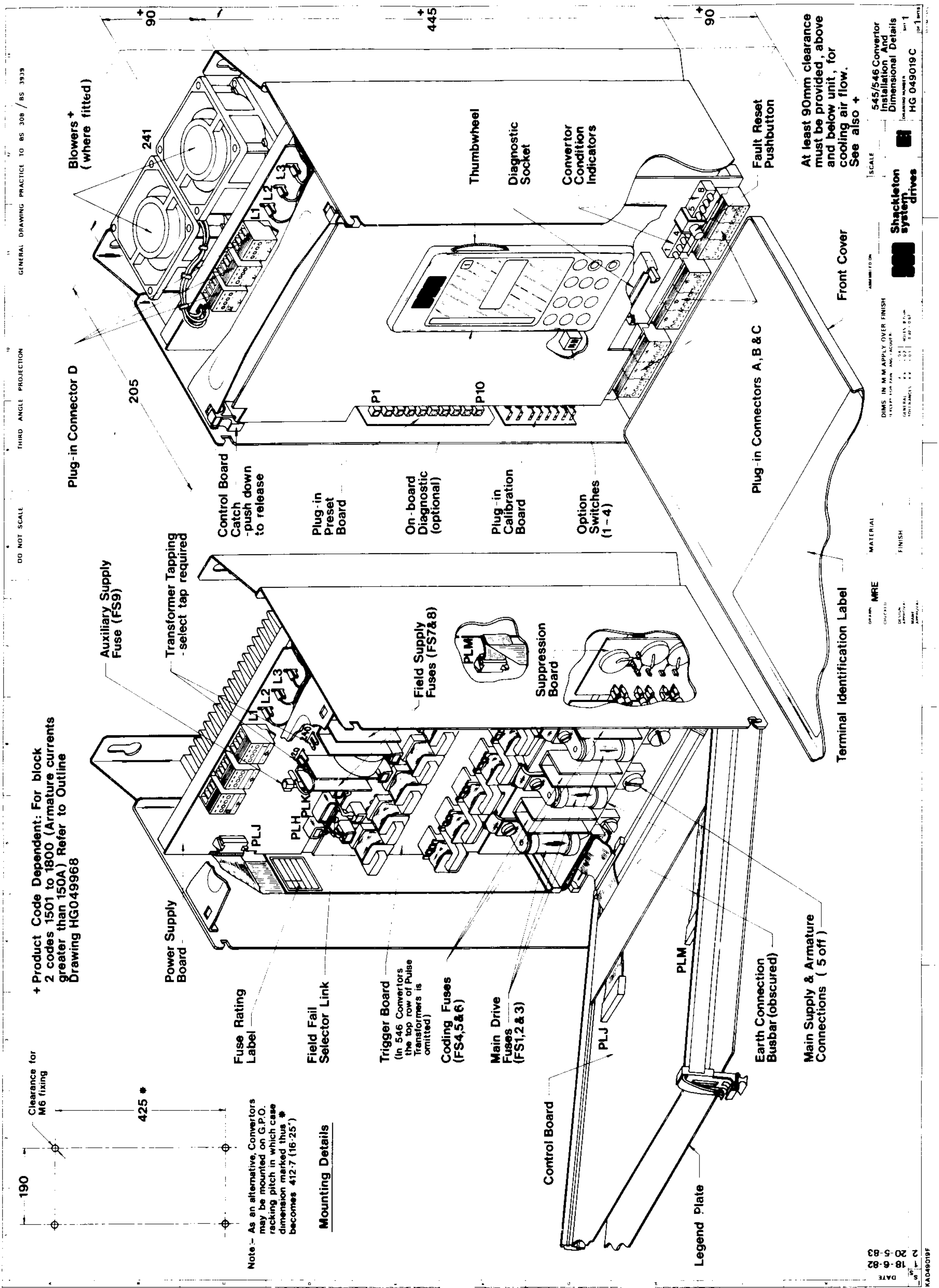

+ Product Code Dependent: For block 2 codes 1501 to 1800 (Armature currents greater than 150A) Refer to Outline Drawing HG049968

Clearance for M6 fixing

190

425 \*

Note: - As an alternative, Convertors may be mounted on G.P.O. racking pitch in which case dimension marked thus \* becomes 412.7 (16.25')

**Mounting Details**

At least 90mm clearance must be provided, above and below unit, for cooling air flow. See also +

DATE: 20-5-82  
18-6-82  
20-5-83  
KAD49019F

DRAWN: MRE  
CHECKED: MRE  
DESIGN APPROVAL: MRE  
MATERIAL: MRE  
FINISH: MRE

GENERAL DIMENSIONS: 445 x 205 x 190  
CONTAINER NO. HG 049019 C  
DRAWING NUMBER: HG 049019 C  
SCALE: 1:1

545/546 Converter Installation And Dimensional Details  
Shackleton system drives  
1 of 1

DO NOT SCALE  
THIRD ANGLE PROJECTION  
GENERAL DRAWING PRACTICE TO BS 308 / BS 3939

DO NOT SCALE THIRD ANGLE PROJECTION GENERAL DRAWING PRACTICE TO BS 308 / BS 3939

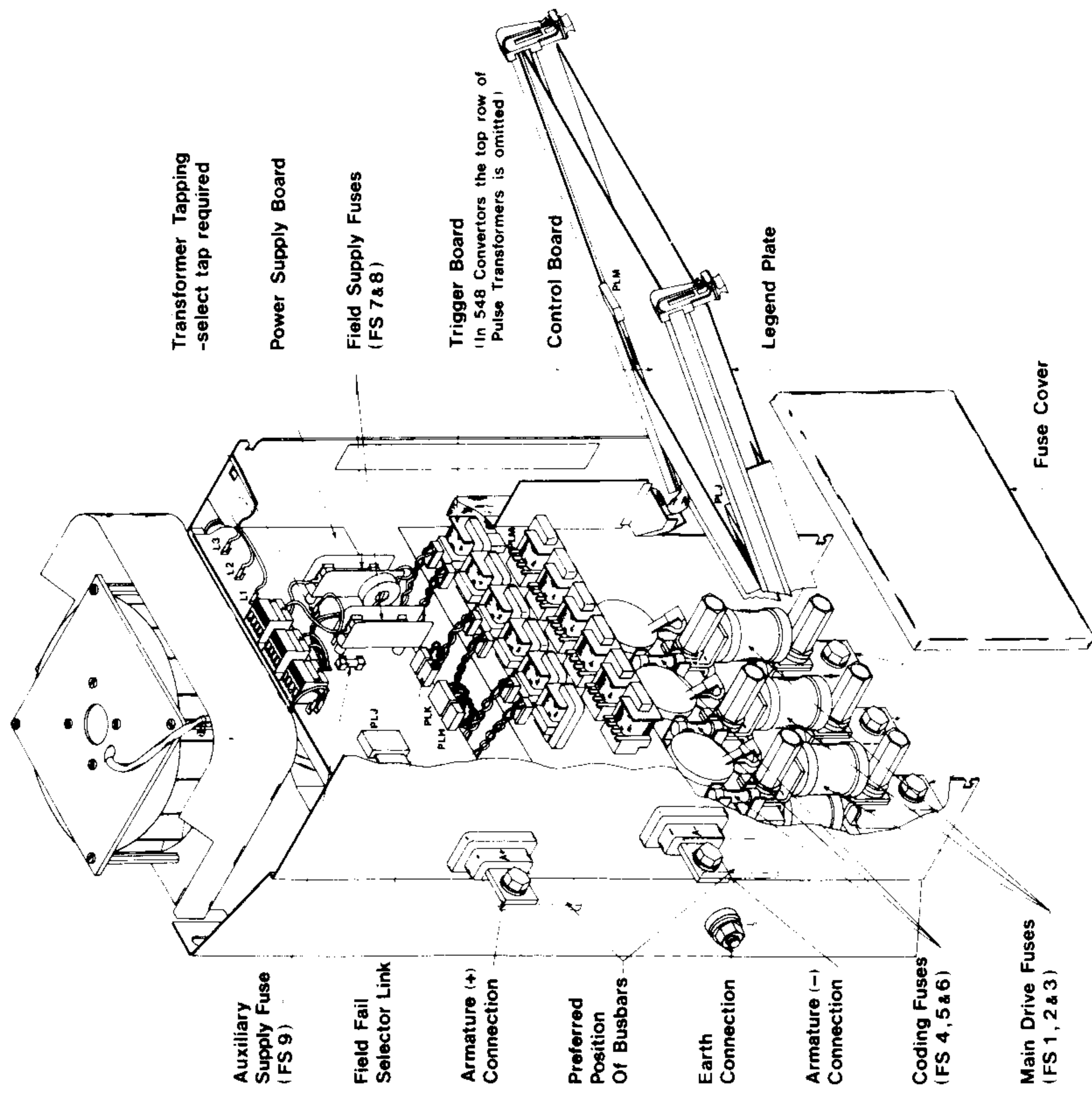
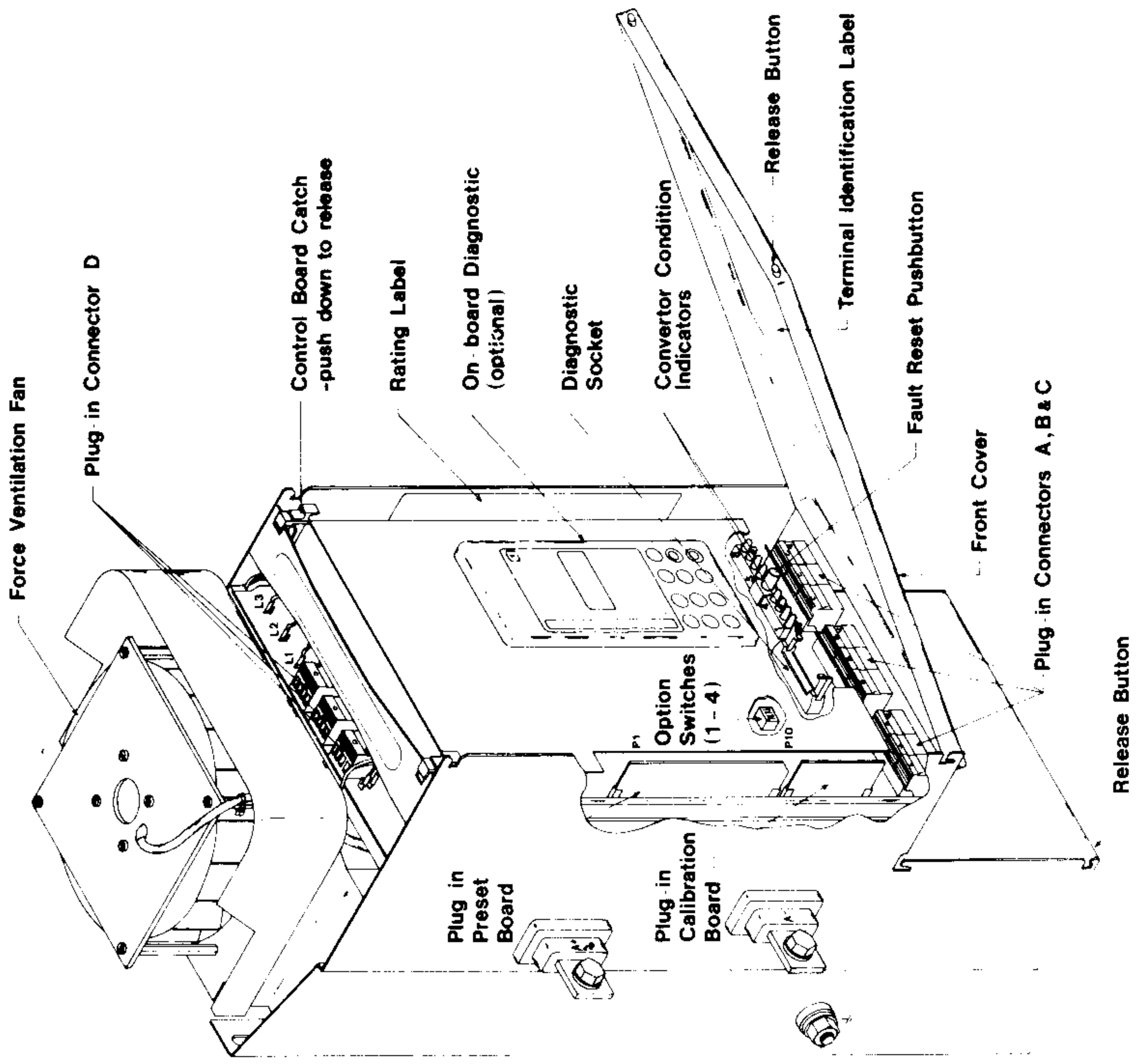

For fixing and outline dimensions see HG 049132  
 (Note air flow requirements)

DATE	1 12 82
DRAWN	DJH
CHECKED	
DESIGNED	
APPROVAL	
MATERIAL	
FINISH	
DIMENSIONS IN MM APPLY OVER FINISH EXCEPT FOR PANTY AND LACQUER.	
GENERAL TOLERANCES	± 0.15 ± 0.10 ± 0.07 ± 0.05
SCALE	1:1
ORDERED NUMBER	HG 049532 C
547/548 CONVERTOR INSTALLATION INFORMATION	
Shackleton system drives	

DO NOT SCALE      THIRD ANGLE PROJECTION      GENERAL DRAWING PRACTICE TO BS308/ BS 3939      10      9      8      7      6      5      4      3      2      1      S      DATE

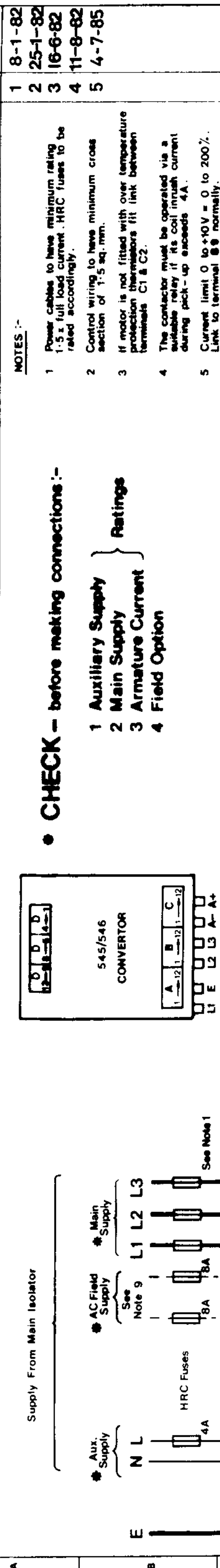

- **CHECK** - before making connections:-
- 1 Auxiliary Supply
  - 2 Main Supply
  - 3 Armature Current
  - 4 Field Option
- Ratings

NOTES:-

- 1 Power cables to have minimum rating 1.5 x full load current. HRC fuses to be rated accordingly.
- 2 Control wiring to have minimum cross section of 1.5 sq. mm.
- 3 If motor is not fitted with over temperature protection thermistors fit link between terminals C1 & C2.
- 4 The contactor must be operated via a suitable relay if its coil inrush current during pick-up exceeds 4A.
- 5 Current limit 0 to +10V = 0 to 200%. Link to terminal B normally.
- 6 If customer interlocks are required insert switches in place of link between terminals C3 & C4.
- 7 Indicator lamps must be switched by auxiliary contacts on contactor - not by controller internal relay.
- 8 Additional stop buttons must be of normally closed type and wired in series with the stop button shown.
- 9 Units with the external field supply option require connection of the A.C. supply to terminals D1 & D4.
- 10 Observe good engineering practice with installation. Ensure that signal wires are separated from high voltage or high current cables. Use screen cables on tachometer connections.
- 11 Terminals D2, D3, D6 & D7 must NOT be used as interconnection points for any control or power wiring.
- 12 Auxiliary current limit (-) is applicable only to 545 Converters.
- 13 Connection shown is normal for 545 Converter. For 546 Converter the CCW terminal is usually connected to 0v signal (Terminal A1 or B1).
- 14 Optional relay connections DOR and ZSR

12	Contactor Coil (L)	Terminal Block D
11	Contactor Coil (N)	Terminal Block D
10	Auxiliary Supply (N)	Terminal Block D
9	Auxiliary Supply (L)	Terminal Block D
8	Field (-)	Terminal Block D
7	(See Note 11)	Terminal Block D
6	(See Note 11)	Terminal Block D
5	Field (+)	Terminal Block D
4	AC Field Supply	Terminal Block D
3	(See Note 11)	Terminal Block D
2	(See Note 11)	Terminal Block D
1	AC Field Supply	Terminal Block D
12	0v (Signal)	Terminal Block A
11	Armature Current Compensation	Terminal Block A
10	Setpoint Ramp Reset	Terminal Block A
9	Setpoint Ramp Input	Terminal Block A
8	Setpoint Ramp Output	Terminal Block A
7	Input no 1	Terminal Block A
6	Input no 2	Terminal Block A
5	Inverted Sub Total	Terminal Block A
4	Input no 3	Terminal Block A
3	Total Setpoint	Terminal Block A
2	+10v Setpoint Reference	Terminal Block A
1	-10v Setpoint Reference	Terminal Block A
12	0v (Power)	Terminal Block C
11	Thermistor/Microtherm	Terminal Block C
10	Auxiliary Enable	Terminal Block C
9	Start Supply	Terminal Block C
8	Enable	Terminal Block C
7	Stop	Terminal Block C
6	Start	Terminal Block C
5	Ready	Terminal Block C
4	Zero Speed Relay Drive	Terminal Block C
3	Drive Operational Relay Drive	Terminal Block C
2	+24v	Terminal Block C
1	Fault Reset External	Terminal Block C

**ASSEMBLED ON**

**SCALE**

**TITLE**  
545/546 Converter.  
Basic Wiring Diagram.

**DRAWING NUMBER**  
HJ 047940D

**DATE**  
8-1-82  
25-1-82  
16-6-82  
11-8-82  
4-7-85

**SHACKLETON SYSTEM drives**

**DIMS IN M.M. APPLY OVER FINISH**  
(EXCEPT FOR PAINT AND LACQUER)

**GENERAL TOLERANCE** X.XX = ± 0.1 | -0.02 + 0.07

**FINISH**

**MATERIAL**

**A.E.B.**

**CHECKED**

**DESIGN APPROVAL**

**MANF. APPROVAL**

**OP 1 ERTS**

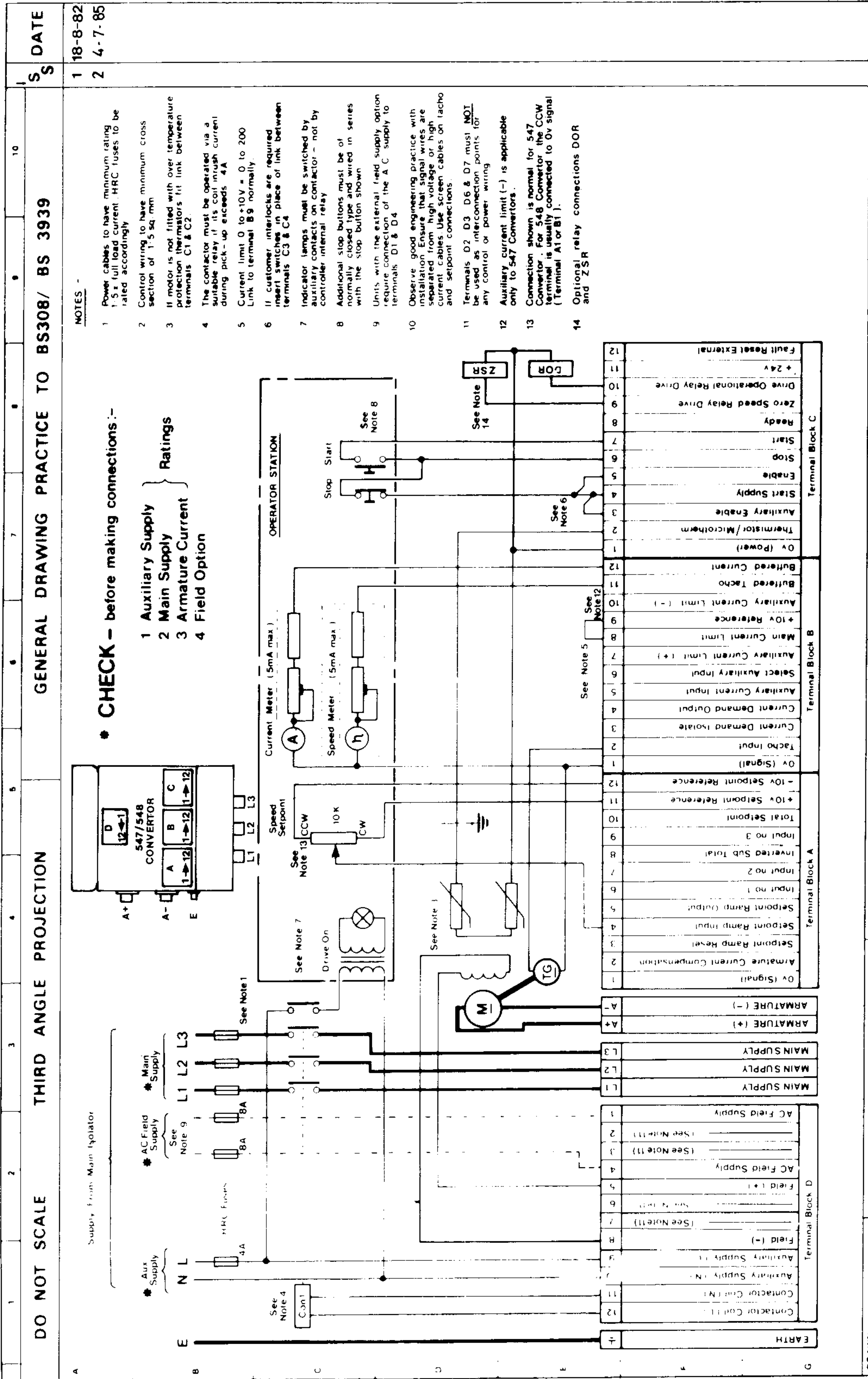

**ASSEMBLED ON**

**SCALE**

**Shackleton system drives**

**TITLE**  
547/548 Converter.  
Basic Wiring Diagram.

**DRAWING NUMBER**  
HJ 049197D

**SHT. 1**  
**OF 1 SHTS.**

**DIMENSIONS IN MILLIMETERS APPLY OVER FINISH**

**EXCEPT FOR PAINT AND LACQUER!**

**GENERAL TOLERANCE** X . . . 0.4  
X X . . . 0.2  
X X X . . . 0.1

**HOLES < Ø7mm** -0.02 - 0.07

**DRAWN A.E.B.**

**CHECKED**

**DESIGN APPROVAL**

**MANUF. APPROVAL**

**MATERIAL**

**FINISH**

**KEO430680**

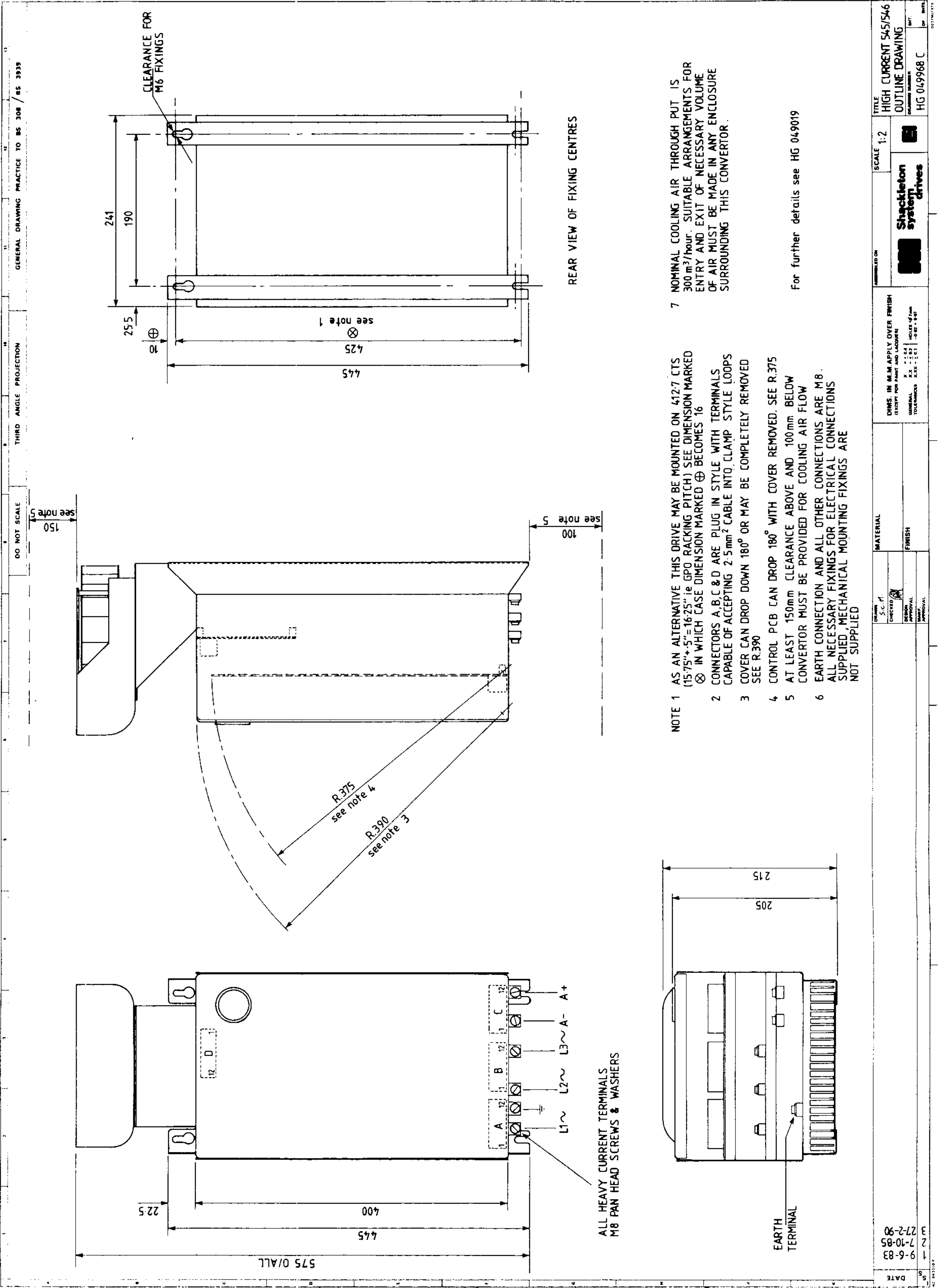

DATE	1 9-6-83	2 7-10-83	3 27-2-83
APPROVAL			
DESIGN			
MATERIAL			
FINISH			
DIMS. IN MM APPLY OVER FINISH EXCEPT FOR PAINT AND LACQUER			
GENERAL TOLERANCES	XX - 0.25	XX - 0.25	XX - 0.25
SCALE	1:2		
TITLE	HIGH CURRENT 545/546		
OUTLINE DRAWING			
DRIVER NUMBER	HG 049968 C		



Shackleton system drives

FOR FURTHER DETAILS SEE HG 049019

96174/01

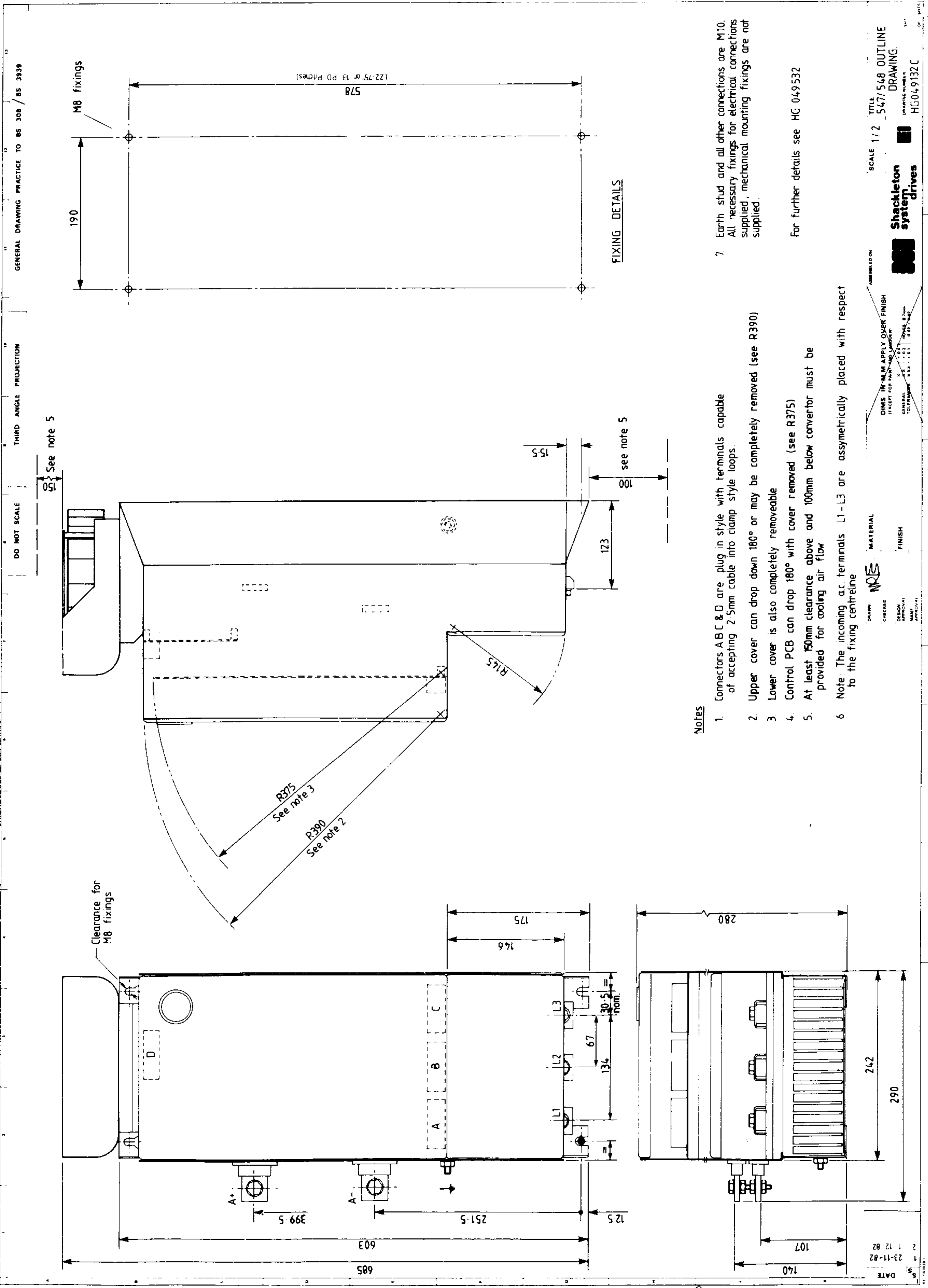

**Notes**

1. Connectors A B C & D are plug in style with terminals capable of accepting 2.5mm cable into clamp style loops.
2. Upper cover can drop down 180° or may be completely removed (see R390)
3. Lower cover is also completely removable
4. Control PCB can drop 180° with cover removed (see R375)
5. At least 50mm clearance above and 100mm below converter must be provided for cooling air flow
6. Note: The incoming ac terminals L1-L3 are asymmetrically placed with respect to the fixing centreline

7. Earth stud and all other connections are M10. All necessary fixings for electrical connections supplied, mechanical mounting fixings are not supplied.

For further details see HG 049532

DATE	1 23-11-82	2 1 12 82
SCALE	1/2	TITLE
DRAWN	MRS	MATERIAL
CHECKED		FINISH
DESIGN		
APPROVAL		
MANUFACTURE		
DIMENSIONS IN MM APPLY OVER FINISH UNLESS OTHERWISE SPECIFIED		
GENERAL TOLERANCES: X 0.15 - 1.51 0.075 - 0.2		
DRAWING NUMBER HG049132C		
Shackleton system drives		



## CONTROLLER TERMINAL DESCRIPTIONS

### TERMINAL BLOCK A

#### A1 0V(SIGNAL)

Zero Volt reference for signal currents only i.e. currents originating from Terminal Blocks A and B. Must not be used as a return point for currents originating from Terminal Block C.

#### A2 ARMATURE CURRENT COMPENSATION OUTPUT

This output is a Buffered Bipolar Armature Current Feedback Signal of  $\pm 1.1\text{V} = \pm 100\%$  Full Load Current.

In Armature Voltage Feedback applications, up to 11% IaRa Compensation can be derived from this Output, adjustable by an external control potentiometer. The control should be a 10K Ohm potentiometer, connected between Terminals A2 and A1, with its wiper connected to Terminal A6 or A7.

This terminal is also used in Field Weakening applications where it is connected directly to Terminal A2 of the Field Controller (Model 5401).

#### A3 SETPOINT RAMP RESET\*

Connect to 0v(Signal) to reset the Setpoint Ramp Output to zero volts, otherwise leave open circuit. The reset is instantaneous and independent of the setting of preset potentiometers P1 and P2.

#### A4 SETPOINT RAMP INPUT\*

Speed reference input to the Setpoint Ramp circuit. Maximum input =  $\pm 10\text{V}$  with respect to 0v(Signal), input impedance = 200K Ohms. See also Inverted Subtotal, A8 and Total Setpoint, A10.

#### A5 SETPOINT RAMP OUTPUT

Under steady-state conditions this output voltage will equal the input voltage on Terminal A4. However when the input voltage is changed, the output will follow at a constant rate dependant upon the settings of presets P1 and P2. These are the Positive Rate and Negative Rate potentiometers, sometimes referred to as Up Rate and Down Rate respectively. They are adjustable over the range 0.25 to 7.5 seconds when Option Switch S4 is ON and 2.5 to 75 seconds when S4 is OFF. Note that "Positive" and "Negative" do not refer to the actual polarity of the Setpoint Ramp Output but to the direction in which it is changing. For example if the Setpoint Ramp Input is more positive than its Output then the rate of change will depend on the setting of the Positive Rate Control. Conversely, if the Input is more negative than the Output, the rate will depend on the setting of the Negative Rate control.

When Option Switch S3 is ON the Setpoint Ramp Output is summed internally with any inputs appearing at Terminals A6, A7 and A9. When S3 is OFF the Output is internally isolated from the other inputs but may be connected externally to A6, A7 or A9 if required.

The Ramp Output is reset to zero if Terminal A3 is connected to 0v(Signal) or if the Run/Inhibit signal is in the Inhibit state (LED 6 not lit). See also Inverted Subtotal, A8 and Total Setpoint, A10.

#### A6 INPUT No.1\*

Speed Reference input. Maximum input =  $\pm 10\text{V}$  with respect to 0v(Signal), input impedance = 20K Ohms. See also Inverted Subtotal, A8 and Total Setpoint, A10.

#### A7 INPUT No.2\*

Speed Reference input. Maximum input =  $\pm 10\text{V}$  with respect to 0v(Signal), input impedance = 20K Ohms. See also Inverted Subtotal, A8 and Total Setpoint, A10.

#### A8 INVERTED SUBTOTAL OUTPUT

Equal to the inverted Algebraic sum of Input No.1, Input No.2 and the Setpoint Ramp Output provided that Option Switch S3 is ON, otherwise equal only to the inverted algebraic sum of Inputs No.1 and Input No.2. See also Total Setpoint, A10.

#### A9 INPUT No.3\*

Inverse Speed reference input. Maximum input =  $\pm 10\text{V}$ , input impedance = 20K Ohms. This input is of the opposite sense to Inputs No.1, No.2 and the Setpoint Ramp Input i.e. if maximum forward speed is required, it can be achieved by applying +10v, to Input No.1 (or Input No.2 or the Setpoint Ramp Input) or by applying -10v to Input No.3. See also Total Setpoint A10.

#### A10 TOTAL SETPOINT OUTPUT

This buffered output is the inverted sum of the Inverted Subtotal Output and Input No.3. Thus it is equal to Input No.1, plus Input No.2, plus the Setpoint Ramp Input (if applicable - see A3 and A5), minus input No.3. The maximum output is limited to approximately  $\pm 1\text{V}$ . In 546 and 548 controllers a Total Setpoint signal of +10v represents a demand for full speed. In the 545 and 547 regenerative controllers +10v demands full forward speed and -10v demands full reverse speed.

#### A11 +10V PRECISION REFERENCE

Setpoint reference supply. This supply is short-circuit proof, but for normal operation the load on Terminal A11 plus Terminal B9 should not exceed a total of 25mA.

#### A12 -10V PRECISION REFERENCE

Setpoint reference supply. This supply is short-circuit proof, but for normal operation the load current should not exceed 25mA. This supply is not normally used in the case of non-regenerative controllers (types 546 and 548).

\*These Terminals should be left open-circuit if not used.

## TERMINAL BLOCK B

### B1 0V(SIGNAL)

Zero voltage reference for signal current only i.e. currents originating from Terminal Blocks A and B. Must not be used as a return point for currents originating from Terminal Block C.

Demand signal must be positive for Armature current to flow. The maximum level of this signal is later modified by the Current Limit circuit (according to the input voltages at Terminals B7, B8 and B10) before comparison with the Current Feedback signal.

### B2 TACHO INPUT

For 'forward' motor rotation, corresponding to a positive Total Setpoint signal, the Tacho feedback voltage at Terminal B2 must be positive with respect to 0v(Signal). Tacho feedback voltages up to 200v should be applied direct to Terminal B2 with calibration resistors (mounted on the plug-in Calibration Board) selected according to the formula:-

$$R19 + R20 = (\text{Full speed Tacho volts} - 10)\text{K Ohms.}$$

If the full speed Tacho feedback voltage exceeds 200v an additional calibration resistor must be added, external to the controller. In this case the resistors should be selected according to the formula:-

$$R19 + R20 + \text{External Cal Resistor} \\ = (\text{Full Speed Tacho volts} - 10)\text{K Ohms,}$$

such that  $R19 + R20$  does not exceed 190K Ohms.

In applications employing DCVT feedback (i.e. where Product Code Block 9 = 13), the calibration resistors should be selected according to the formula:-

$$R19 + R20 = (\text{DCVT Output Voltage} \\ \text{at Full Speed} - 1)\text{K Ohms.}$$

In all cases the calibration resistors should be of a robust, high stability type.

The input impedance at this terminal depends on the value of the calibration resistors but will lie in the range 10 to 50K Ohms (1 to 50K Ohms in DCVT applications).

### B3 CURRENT DEMAND ISOLATE\*

Connect B3 to 0v(Signal) to cause disconnection of the current demand signal from the input of the current loop. This facility may be required in some Torque Control or special applications where the Current Demand signal is input to the Current Loop via Terminal B5 (See B5 and B6). For Speed Control applications this Terminal is normally left open circuit.

### B4 CURRENT DEMAND OUTPUT\*

This Current Demand signal is the output from the speed loop integrator. It is connected directly to the input of the Current Loop except when Current Demand Isolate is at 0V (See B3 Terminal description).

In Speed Control applications the voltage at B4 depends upon the motor speed and load conditions. Zero volts represents a demand for zero Armature current while +10v and -10v represent a demand for +200% and -200% of Full Load Current respectively.

In the case of 546 and 548 Controllers the Current

### B5 AUXILIARY CURRENT INPUT\*

This Terminal allows direct access to the input of the Current Loop and is used for some Torque Control and special applications. An input at this Terminal will be connected to the input of the Current Loop if Terminal B6 is connected to 0v(Signal), Terminal B1. Connect Terminal B3 to 0v(Signal) to prevent addition of the Current Demand signal to the Auxiliary Current Input Signal. An Auxiliary Current Input of 0v represents a demand for zero Armature current while +10v and -10v represent a demand for +200% and -200% of Full Load Current respectively. In the case of 546 and 548 controllers the Auxiliary Current Input signal must be positive for Armature current to flow. The maximum level of this signal is later modified by the Current Limit circuit (according to the input voltages at Terminals B7, B8 and B10) before comparison with the Current Feedback signal.

### B6 SELECT AUXILIARY INPUT\*

If this Terminal is connected to 0v(Signal) any input at Terminal B5 will be connected through to the input of the Current loop and will be added to the Current Demand Signal (see also Current Demand Isolate, Terminal B3). In Speed Control applications Terminal B6 is normally left open circuit.

### B7 AUXILIARY CURRENT LIMIT (+)\*

This input provides independent control of the positive Armature current limit, from zero up to the maximum allowed by the Main Current Limit setting (see B8 Terminal description). If this facility is not required Terminal B7 should be left open circuit, in which case Auxiliary Current Limit (+) is disabled by an internal pull-up resistor and control reverts to the Main Current Limit.

The control voltage range at Terminal B7 is 0 to +10v = 0 to +200% Full Load Current. The input impedance is approximately 25k Ohms. Because of the internal pull-up resistor adjustment of the Terminal voltage can be made by an external resistor connected between B7 and 0v(Signal). Alternative methods of control are a potentiometer (ends connected to B9 and B1, wiper to B7) or an analogue voltage in the range 0 to +10v. Negative voltages MUST NOT normally be applied to this input.

### B8 MAIN CURRENT LIMIT

The Main Current Limit provides symmetrical control of both positive and negative Armature current limits. If different positive and negative current limits are required see B7 and B10. When external control of the Main Current Limit is not required B8 should be connected to +10v (Terminal B9). The input voltage at Terminal B8 supplies the Main Current Limit preset potentiometer P7, thus

\*These Terminals should be left open-circuit if not used.

the actual current limit value depends upon the voltage at B8 and the setting of P7. Assuming that P7 is set fully clockwise, the control voltage range at Terminal B8 is 0 to +10v = 0 to  $\pm 200\%$  Full Load Current (0 to +200% Full Load Current in the case of 546 and 548 controllers). A negative input voltage MUST NEVER be applied to this Terminal.

#### B9 +10V PRECISION REFERENCE

Setpoint reference supply. This supply is short-circuit proof but for normal operation the load on Terminal A11 plus Terminal B9 should not exceed a total of 25mA.

#### B10 AUXILIARY CURRENT LIMIT (-)\*

This input provides independent control of the negative Armature current limit, from zero up to the maximum allowed by the Main Current Limit setting (see B8 Terminal description). If this facility is not required (and in all 546 and 548 applications) Terminal B10 should be left open circuit, in which case the Auxiliary Current Limit (-) is disabled by an internal pull-up resistor and control reverts to the Main Current Limit.

The control voltage range at Terminal B10 is 0 to -10v = 0 to -200% Full Load Current. The input impedance is approximately 25K Ohms. Because of the internal pull-up resistor adjustment of the Terminal voltage can be made by an external resistor connected between B10 and 0v(Signal). Alternative methods of control are a potentiometer (ends connected to A12 and B1, wiper to B10) or an analogue voltage in the range

0 to -10v. Positive voltages MUST NOT normally be applied to this input.

#### B11 BUFFERED TACHO OUTPUT

This output has the same polarity as the Tachogenerator input voltage on Terminal B2 but is attenuated so that 0 to  $\pm 100\%$  Full Speed is represented by an output of 0 to  $\pm 10v$ . The output is short-circuit proof and may be used to supply speed indicator or speed sensing circuits up to a maximum load current of 5mA.

#### B12 BUFFERED CURRENT OUTPUT

This output is short-circuit proof and may be used to supply Armature current Indicators or sensing circuits up to a maximum load current of 5mA. Modulus or Bipolar outputs are available depending upon the setting of Option Switch 1. For centre-zero indicators S1 should be ON (UP) so that the output is Bipolar i.e. positive and negative Armature currents are represented by positive and negative outputs at Terminal B12.

For end-zero indicators S1 should be OFF (DOWN) so that the output represents the Modulus of the Armature current i.e. both positive and negative Armature currents are represented by a positive output at B12. In either case an output of 10v represents an Armature current of 200% Full Load, 5v represents 100% Full Load Current etc. In 546 and 548 applications the setting of S1 is immaterial since these units only produce positive Armature current.

---

### TERMINAL BLOCK C

#### C1 0V(POWER)

Zero Volt connection for power currents only i.e. current originating from Terminal Block C. This terminal must not be used as a return point for signal currents originating from Terminal Blocks A and B.

#### C2 THERMISTOR/MICROTHERM

Motor overtemperature sensors should be connected between Terminals C1 and C2. The drive will be disabled if the external resistance between C1 and C2 exceeds 1.8K Ohms  $\pm 200$  Ohms (see C8 and C10 Terminal descriptions). The drive may restart automatically when the resistance (i.e. motor temperature) falls - see C3 Terminal description. Suitable temperature sensors are thermostatic switches (e.g. microtherms) or a pair of series connected P.T.C. thermistors. If over temperature sensors are not used Terminals C1 and C2 must be linked.

#### C3 AUXILIARY ENABLE

This input is normally connected to Terminal C4. If required, external normally-closed interlock

contacts may be inserted between Terminals C3 and C4.

The drive will be disabled when the input to C3 is open circuit or if the input voltage is less than approximately +10v (see C8 and C10 Terminal descriptions).

#### NOTE:

The Thermistor/microtherm and Field failure alarms normally disable the drive only while a fault exists; if the fault clears, because the motor cools down for example, the motor will restart automatically. However, these alarms can be made to latch the drive in the disabled state indefinitely by connecting C3 to C10 instead of C4 (any external interlock contacts connected in the C3 to C10 link will also be latched in this manner). In this mode a Thermistor/microtherm, Field failure or external interlock alarm condition can only be cleared, and the motor restarted, by operating the start/stop controls.

#### C4 START SUPPLY

This terminal is normally connected to Terminals C3 and C5 and to the Start/Stop control circuit.

\*These Terminals should be left open-circuit if not used.

In systems employing separate momentary contact Start and Stop switches, C4 should be connected to the normally closed Stop contact. If a single maintained contact Start/Stop switch is used it should be connected between Terminals C4 and C7. The Start supply is present whenever the Auxiliary Supply is on (see D9 and D10 Terminal descriptions), provided that an overcurrent Trip has not occurred. If such a Trip does occur the Start Supply can be restored by operating the Fault Reset button (under the front cover of controller), or by applying +24v (from Terminal C11) to Terminal C12.

#### C5 ENABLE

Normally connected to Terminal C4, the drive will be disabled when this input is open circuit or when the input voltage is less than approximately +3v.

#### C6 STOP

In systems employing separate Start and Stop controls this Terminal is wired to the common interconnection point of the two switches. If a single maintained contact switch is used for Start/Stop control then no connection should be made to this Terminal. (See also C4 and C7 Terminal description).

#### C7 START

When the Start Supply from Terminal C4 is applied to this Terminal via the Start control, the internal contactor control relay will be energised. This in turn will energise the (external) three phase supply contactor. If separate Start and Stop controls are used C7 should be connected to the normally open, momentary contact of the Start switch. When Stop/Start control is by a single maintained contact it should be connected between Terminals C4 and C7. See also C4 and C6 Terminal descriptions.

#### C8 READY OUTPUT

This is the output of a fault detector circuit which monitors 8 internal Alarm signals. Its output is approximately +22 to +30 volts at 50mA maximum and may be used to supply an external indicator or relay connected between Terminals C8 and C1. The drive will run when this output is high (+22v to +30v) and the Enable input Terminal C5 is high (+12v to +30v).

The Ready Output will be high when all of the following conditions are met:-

- 1) Single phase Auxiliary Supply present, fuse FS9 good, Calibration and Preset printed circuit boards correctly inserted.
- 2) Drive synchronised to supply frequency in the range 45 to 65 Hz.
- 3) Three phase supply present, fuses FS1 to FS6 all good.
- 4) Field current present (or Field Failure override selected) and Stack Thermal Trip not open

(force ventilated units only).

- 5) Start instruction issued, contactor control relay latched, three phase contactor closed.
- 6) Resistance between Terminals C1 and C2 (Thermistor/microtherm) less than approximately 1.8K Ohms  $\pm$ 200 Ohms.
- 7) Auxiliary Enable input voltage (Terminal C3) approximately +10v to +30v.
- 8) Armature current waveform normal.

Note that if an abnormal current waveform is detected, Drive Condition Indicator LED 4 will not light. If this occurs press the Fault Reset button which is located beneath the controller front cover. Alternatively apply +24v (from Terminal C11) to the Fault Reset (External) Terminal, C12.

#### C9 ZERO SPEED RELAY DRIVE

This output is intended to supply a 24 volt (D.C.) relay at an output current not exceeding 50mA. The relay should be connected between Terminals C9 and C1; it will be energised when the Speed Feedback signal is lower than the Standstill Threshold set by preset potentiometer P4 (P4 has a range of  $\pm$ 0.5 to  $\pm$ 4% of Full Speed).

#### C10 DRIVE OPERATIONAL RELAY DRIVE

This output is intended to drive a 24 volt (D.C.) relay at an output current not exceeding 50mA. The relay should be connected between Terminals C10 and C1; it will be energised when C10 is high (+24V nominal) and de-energised when C10 is low (0V).

When the Auxiliary Supply is connected to the drive the relay will energise and will only be de-energised if the Ready Output (Terminal C8) is disabled while the Start Supply is present at Terminal C7.

This output can also be used to latch the Thermistor/microtherm, Field failure and external interlock alarms - see C3 Terminal description.

The Drive Operational output at C10 depends upon the Stop/Start condition of the drive, as follows:

- (i) When the drive is in the Start condition (Start Supply present at Terminal C7), the output at C10 depends upon the Ready Output at C8, i.e. C10 will be high if C8 is high, C10 will be low if C8 is low.
- (ii) When the drive is in the Stop condition the output at Terminal C10 will always be high, even though the Ready Output is low.

#### C11 +24V (NOMINAL)

This is a +22 to +30v unregulated D.C. supply which may be used to supply the Enable and Fault Reset (External) inputs.

#### C12 FAULT RESET (EXTERNAL)

If external Fault Reset control is required connect this Terminal to Terminal C11 via a normally open momentary contact.

## TERMINAL BLOCK D

D1 AC FIELD SUPPLY  
D4 AC FIELD SUPPLY

External A.C. input to the Field Rectifier Bridge. Controllers with Field Options 5 or 6 (Product Code Block 4) require an A.C. input to these Terminals. The actual input required will depend on the Motor Field rating and the Field Rectifier configuration. The input voltage may be calculated as follows:-

For Field Option 5 (Full-wave Rectifier Bridge):-

Required AC input voltage  
= 1.1 x Rated Field voltage

For Field Option 6 (Half-wave Rectifier Bridge):-

Required AC input voltage  
= 2.2 x Rated Field voltage

In the case of Controllers with Field Options 2 or 3 the supply to the Field rectifier is derived from Line 1 and Line 2 within the drive. Consequently, no input is required at Terminals D1 and D4.

In all Controllers which contain a Field Supply (i.e. Field Options 2, 3, 5 and 6) the A.C. supply to the Field Rectifier is internally fused at 8A (fuses FS7 and FS8). The Field supply configuration of these units can be modified as follows, but ensure that any modifications are entered on the Controller Rating Label:-

Plug-on wire connections from FS7 and FS8 are used to select internal or external A.C. field supply:

- (i) For internal A.C. supply from L1 and L2 connect the wires to the two pins marked "FI".
- (ii) For external A.C. supply via Terminals D1 and D4 connect the wires to the two pins marked "FE".

D5 FIELD (+)  
D8 FIELD (-)

Motor Field Connections.  
The D.C. output voltage at these Terminals will depend upon the A.C. supply voltage and the Field Rectifier configuration.  
For controllers with Field Options 2 and 3 the

output voltage may be calculated as follows:

For Field Option 2 (Full-wave Rectifier Bridge):-

DC output voltage = 0.9 x 3-phase supply  
voltage (Line-Line)

For Field Option 3 (Half-wave Rectifier Bridge):-

DC output voltage = 0.45 x 3-phase supply  
voltage (Line-Line)

For Field Options 5 and 6 see D1 and D4 Terminal description.

D9 AUXILIARY SUPPLY (L)  
D10 AUXILIARY SUPPLY (N)

Mains input to the control supply transformer and the contactor control relay. The input to these Terminals is product code dependent - ensure that the input voltage complies with the selected control transformer tapping - application of the wrong supply voltage may cause damage to the controller.

If at any time the transformer tapping is changed it is essential that the Controller Rating Label is amended to show the correct voltage and Block 3 code.

D11 CONTACTOR COIL (N)

This Terminal is internally connected to Terminal D10 and provides a connection point for the contactor neutral wire.

D12 CONTACTOR COIL (L)

This is the switched output from the contactor control relay and is derived from the line supply at Terminal D9. The line supply is internally fused at 3A (FS9), hence contactors having a high inrush current during pick-up must be operated via a suitable slave relay.

D2 NO CONNECTION  
D3 NO CONNECTION  
D6 NO CONNECTION  
D7 NO CONNECTION

These unused positions provide additional isolation between adjacent high voltage Terminals, they MUST NOT be used as interconnection points for any control or power wiring.

## BLOCK DIAGRAM DESCRIPTION

### A. POWER CONFIGURATION

Three phase power is supplied to the AC input terminals (L1, L2 & L3) of the drive via an external isolating contactor. The phase rotation (phasing) of the supply is unimportant. Three semiconductor fast blow fuses (F1, F2 & F3) are incorporated in the package to protect the thyristor stack. Three auxiliary fuses (F4, F5 & F6) protect the internal power wiring and suppression networks.

The thyristor stack is fully suppressed to prevent damage caused by over voltage or supply bourne transients.

#### FIELD SUPPLY

The DC supply for field excitation is available from terminals D5 (positive) and D8 (negative). It is obtained from an on board half or full wave diode bridge rectifier (according to Product Code). The AC supply for this rectifier can be internally connected to the line to line supplies or can be supplied through terminals D1 and D3 by internal link selection (see Product Code). The field rectifier is always protected by two high speed semiconductor fuses (F7 & F8) contained in the drive, regardless of where the field AC supply is derived. Non linear surge suppressors protect the rectifier from supply bourne transients.

The field current is measured using a small AC current transformer to provide an isolated logic signal which falls to zero and stops the drive in the event of "field failure" (Diagnostic 7). The field failure condition can be over ridden when required by the internal link labled "Field Fail Override".

#### AUXILIARY SUPPLY

The auxiliary single phase AC supply which powers the drive electronics is connected to terminals D9 (line) and D10 (neutral). The line supply is fused via a 3 Amp control fuse (F9) to the multitapped power supply transformer and to the contactor control relay within the drive, it also provides the fan supply in force ventilated units.

#### CONTACTOR CONTROL

The contactor control relay is operated from the isolated low voltage drive at terminal C4 via external Stop/Run pushbuttons. Its suppressed power contacts provides a switched version of the auxiliary line voltage on terminal D12 (line) and D11 (neutral) to energise the isolating contactor. The contactor control relay will be de-energised in the event of detecting abnormally high armature current in the motor and will hence remove the 3-phase supply from the drive. Drive Condition Indicator 5 will be extinguished and until the Fault Reset push button is operated (or the external reset from terminal C12) the isolating contactor cannot be re-energised. The switching capability of the internal relay is 3 Amps inductive up to 240V AC max. For contactors with higher voltage or current ratings, an external slave relay should be interposed between the internal relay and the three phase isolating contactor.

#### SYNCHRONISATION

Isolated synchronising signals to ensure the correct

firing sequence of the six or twelve bridge thyristors are derived from the fused 3-phase supply lines via a signal isolating transformer and two optically coupled isolators. The synchronising circuits are insensitive to variation of the following supply parameters:

- i) Phase Rotation
- ii) Supply voltage (over the range 220-480V  $\pm 10\%$ )
- iii) Supply frequency (over the range 50-60Hz  $\pm 5\%$ )

This caters for all world wide supply conditions.

If one or more of the supply lines is lost or if a fuse (F1-F6) ruptures the drive is held in inhibit, Indicator 3 will extinguish and no power will be delivered to the load.

### B. THE CONTROL OPERATION

#### ISOLATION

The drive control circuits are fully isolated from the Auxiliary and 3-Phase Mains Supplies and this is indicated on the block diagram by the dotted isolation boundary on the right;

- i.e.
1. Armature current is sensed by the 2 line AC current transformers to provide an isolated and normalised signal of 1.1v = 100% Full Load.
  2. Synchronising signals are provided by a signal AC current transformer and two optoisolators.
  3. Thyristor gate pulses are independently isolated by 6 or 12 pulse transformers on the trigger board.
  4. Field current is sensed via an AC current transformer to provide an isolated field failure alarm signal.
  5. An isolated speed feedback signal is provided by a tachogenerator or from the armature voltage via an externally connected DC voltage transformer. It is then normalised to 10v = 100% Full Speed.
  6. Isolated control power supplies are generated from the Auxiliary Supply by the control supply transformer.
  7. Control of the 3-phase contactor coil is isolated by allowing Start and Stop buttons to operate an internal slave relay driven from a low voltage (24 Volts nominal) control signal.

#### POWER SUPPLIES

Stabilised internal supplies of  $\pm 15$  volts DC (Diagnostics 1 & 4 respectively) and  $\pm 10$  volts DC (reference quality) are generated from the single phase Auxiliary Supply via the control supply transformer. The external  $\pm 10$ v DC supplies (Diagnostics 2 & 3 respectively) are buffered within the drive. A smoothed unsmoothed rail of 24 Volts DC nominal, is available at terminal C11 for higher current requirements. These rails are protected against accidental short term overloads and fuse F9 (3A) on the Power Supply P.C.B. protects the wiring.

#### SPEED REFERENCE

4 Quadrant Operation: The speed signal is ten volts positive, to ten volts negative, corresponding to full

speed forward and full speed reverse and is fed into terminal A4, Setpoint Ramp Input (Diagnostic 11). It can be generated by connecting a potentiometer (typical value 10K Ohms) from +10v (terminal A11) and -10v (terminal A12), or by feeding in  $\pm 10$  volts from an external source. Zero volts corresponds to zero speed.

2 Quadrant Operation: The speed signal is ten volts positive, to zero volts, corresponding to full speed forward and zero speed, and is fed into terminal A4, Setpoint Ramp Input (Diagnostic 11). It can be generated by connecting a potentiometer (typical value 10K Ohms) from +10v (Terminal A11) and 0v (Terminal A1), or by feeding in +10 to 0 volts from an external source.

The setpoint is rate limited by a linear ramp generator which has independently adjustable Up (P1) and Down (P2) rates. The span of these rates is also adjustable using switch S4. The Setpoint Ramp Output is brought out to terminal A5 so that other drives may share it as a common setpoint. The Ramp Output is reset to zero when the drive is in an inhibit condition, it may also be reset externally by applying 0v to terminal A3, (when this function is not required terminal A3 is left open circuit).

Three alternative input channels are available which by-pass the ramp unit, these are labeled Setpoint No. 1, (terminal A6, Diagnostic 12), Setpoint No. 2, (terminal A7, Diagnostic 13), and Setpoint No. 3, (terminal A9, Diagnostic 14), they each have the same sensitivity as the main input channel.

The total sum of the inputs is available as Total Setpoint on a buffered output terminal A10 (diagnostic 15). The algebraic summation of all these input channels is:

$$\text{Ramp input (A4) + SP. No. 1 (A6) + SP. No. 2 (A7)} \\ - \text{SP. No. 3 (A9) = Total SP. (A10)}$$

An Inverted Subtotal is also available on terminal A8, which is the summation of two inputs:

$$\text{SP. No. 1 (A6) + SP. No. 2 (A7)} \\ = \text{Inverted Subtotal (A8)}$$

#### NOTE:

The Setpoint Ramp Output is only available internally if option switch S3 is closed, otherwise it is completely isolated from the rest of the drive.

It is recommended that all setpoint connections are made using screened leads. Unused inputs can be left open circuit.

#### SPEED FEEDBACK

The speed feedback signal is normally obtained from a DC tachogenerator and connected to terminal B2 (positive for normal direction of rotation) and should not exceed 200v. It is scaled within the drive to give 10 volts (diagnostic 16) at full speed and is available on terminal B11 as a buffered output for speed indicators. Coarse scaling of the tacho signal is made by selecting resistors (R19 and R20) on the calibration board so that R19 + R20 (in Kilohms) equals the tachogenerator output at full speed. This is normally prescaled to order, fine adjustment of the top speed may be made via trimpot P10 on the Preset Board.

The drive also contains protective circuitry such that in the event of loss of speed feedback (i.e. tachogenerator failure) the motor speed will not rise excessively. This action occurs when the speed

feedback term is less than 0.5% to 4%, (adjustable using trimpot P4 on the Preset Board) and limits the maximum output voltage of the drive. This condition still allows rated armature current to be produced at low speeds and when the speed feedback term exceeds this level, (confirming tachogenerator operation) the limit is removed and normal control action is resumed.

#### ARMATURE VOLTAGE FEEDBACK

It is also possible to obtain an approximate speed feedback signal directly from a measurement of armature voltage because, assuming fixed excitation (constant field supply), the terminal voltage of the armature,  $V_t$ , is given by:

$$V_t = E_b + I_a R_a,$$

where  $E_b$  is the generated back emf which is proportioned to speed and  $I_a R_a$  is the resistive volt drop across the armature when current is flowing.  $V_t$  is measured by using a DC isolating transformer to produce a normalised isolated feedback signal in place of the tacho feedback signal. The difference between  $V_t$  and "true" speed signal  $E_b$  is then accounted for by adding a signal proportional to  $I_a R_a$  to the speed demand. The output at terminal A2 (Armature Current Compensation) is proportional to  $I_a R_a$  and if connected via an external potentiometer into either Setpoint No. 1 or No. 2 and can add up to 11% of full speed, depending upon the setting of the potentiometer.

The potentiometer is correctly adjusted when the motor speed remains constant under varying load conditions. Under-compensation will result in reduced shaft speed as the load is increased. Over-compensation will result in the shaft speed increasing as the load is increased and may result in severe torque oscillation - this must be avoided.

#### ZERO SPEED SENSING

When the speed feedback signal is less than 0.5% to 4% (as set by P4) the Zero Speed Relay Driver is energised such that external terminal C9 sources +24v to drive an external relay.

#### SPEED ERROR

The combined setpoints are compared with the tacho feedback signal on an error amplifier (Diagnostic 17) such that the Speed Signal is always made equal to the Total Setpoint. An offset trimpot P3 is available on the Preset Board to allow the offsets to be reduced to zero. It is not possible to achieve zero speed on demand of a zero speed setpoint without the motor shaft creeping round at a very low speed however accurately the offset is trimmed. However, if absolute zero speed is required, then operating Option Switch S2 will enable the Standstill Logic. This will operate when the Total Setpoint is below 0.5% and the motor speed is below 4% - 0.5% as set by trimpot P4. In this condition a quench action is employed and no firing pulses are applied to the thyristor bridge. If however the Total Setpoint or the speed feedback exceed the thresholds the Standstill Logic will be disabled, the quench action removed and firing pulses are again applied to the thyristor bridge, thus allowing armature current to flow.

The gain of the Error Amplifier is adjustable (by P5 on the Preset Board) over a 10 to 1 range to provide control of the stability and dynamic performance of the drive. This adjustment does not affect the steady state speed holding accuracy of the drive.

## CURRENT DEMAND

The error signal is passed through a 2-Term (Proportional plus Integral) amplifier (Diagnostic 18) which ensures very high DC loop gain, thus achieving accurate steady state speed control and good dynamic performance by correctly optimising the low and high frequency gain of the system for small and large signals. The Integral time constant is adjustable over a 10 to 1 range using trimpot P6 on the Preset Board. The output of this 2-Term amplifier becomes the armature Current Demand signal under normal conditions and is also available on external terminal B4. However it may be isolated from the following stages by a solid state switch when terminal B3 (Diagnostic 19) is connected to 0v, (otherwise this terminal is left open circuit). The Auxiliary Current Input (terminal B5, Diagnostic 20) can also provide the Current Demand signal or be algebraically added to the 2-Term output, via a solid state switch. If this facility is required terminal B6 (Diagnostic 21) must be connected to 0v, otherwise this terminal is left open circuit.

## MAIN CURRENT LIMIT

The Armature Current Demand signal then controls the magnitude of armature current and hence clamping the maximum excursion of this signal limits the maximum armature current that can flow. The reference for the clamp is taken from trimpot P7 on the Preset Board. The top of this potentiometer is available externally at terminal B8 and is normally connected to terminal B9 (+10v), thus +10v as measured on the wiper of P7 (Diagnostic 24) corresponds to 200% armature current. Terminal B8 can also be controlled by an external source such that the maximum armature current can be programmed according to some other control strategy.

For any current setting between 110% and 200% of full load, the actual current level is monitored by an overload integrating circuit. The output of this circuit pulls down the current limit setting progressively to 110% at a rate which is proportional to the overload magnitude,

i.e.: An inverse time characteristic which typically allows 200% current for ten seconds after which the level is automatically reduced to 110%, on a time curve which would allow 150% for about 30 seconds, and so on.

Reduction of the overload produces resetting of the overload capability in the same way,

i.e.: The lower the current level is taken below 100%, and the longer it spends below 100%, then the faster the reset for 200% capability.

## AUXILIARY CURRENT LIMITS

Two auxiliary current limit clamps are also provided, one acting on the demand for positive current, the other acting on the demand for negative current (in 4 quadrant convertors only). These clamps are programmed via external terminal B7, Auxiliary Current Limit Positive (Diagnostic 22) and B10, Auxiliary Current Limit Negative (Diagnostic 23). A positive reference value on B8 or a negative reference value on B10 will limit the armature current between these values from  $\pm 10v = 200\%$  to  $0v = 0\%$ . However the Main Current Limit reference from trimpot P7 will always override the auxiliary clamps, thus always maintaining safe values of

armature current. If these auxiliary clamps are not required then external terminals B8 and B10 should be left open circuit.

## CURRENT FEEDBACK

The three phase power lines are passed through two AC current transformers which are used to provide an isolated, normalised (1.1 volt = 100% F.L.C.) internal current feedback signal (Diagnostic 26) for the current loop. If an indicator is required to display the armature current a buffered output is available on terminal B12 normalised to 5 volt = 100% Full Load. For convenience of display, in 4 quadrant convertors this signal may be bidirectional or unidirectional, depending upon the condition of option switch S1.

## CURRENT CONTROL LOOP

The final current demand (Diagnostic 25), after the Main and Auxiliary Current Limits, is compared with the armature current feedback signal in the current loop controller. The current loop controller has Proportional plus Integral action. Trimpot P8 controls the Proportional term and trimpot P9 controls the Integral time constant. Refer to the setting up procedure to optimise P8 and P9 for the specific motor in use.

The output of the current loop controller, the phase angle signal (Diagnostic 27), then controls the conduction angle of the thyristors and hence the DC output voltage of the stack.

## C. START AND STOP SEQUENCING

### READY OUTPUT

To control the safe start up and shut down of the drive under normal and fault conditions a single inhibit signal (Indicator 6) is generated by an eight input "AND" gate. When all eight inputs are present indicating that no fault conditions exist, the Ready Output (terminal C8) is switched to +24 volts. The Ready Output may be used to produce synchronous starting of multimotor drive systems.

### ALARM SIGNALS

The inputs to the eight input "AND" gate are:

- 1) PRESET BOARD: The Preset and Calibration boards are electrically interlocked. In the event of their removal or absence the drive is quenched and Indicator 1 is extinguished (Note: removal of the preset and calibration boards whilst the drive is operating is not recommended).
- 2) 3-PHASE PRESENT: To ensure that all three phases of the incoming supply are present and of sufficient amplitude, a detection circuit utilising an optoisolator produces a logic level indication. This also detects the loss of any of the supply or suppression fuses F1-F6. Indicator 3 will extinguish if these requirements are not satisfied.
- 3) FIELD FAILURE: In the event of Field Failure (when the field current drops below 100mA) or if the field supply or fuses F7 and F8 are lost the output from the field detection circuit falls (Diagnostic 7) and the drive is quenched.



- 4) P.L.L. SYNCHRONISATION: To ensure that the 3-Phase supply to the drive lies in the range 45-65Hz. Indicator 2 illuminates when synchronisation is complete.
- 5) MISSING PULSE DETECTION: In the event of thyristor trigger faults, the armature current can become very distorted, and although outwardly operation is satisfactory, the motor will experience severe heating which can cause failure. Approximately 30 seconds after this condition is detected (a timer is used to ensure that setpoint noise and ripple is not the cause) a latching trip will quench the drive and Indicator 4 will extinguish. The trip can only be reset by the removal of all supplies (including the Auxiliary Supply) or by operating the Fault Reset\*.
- 6) THERMISTOR/MICROTHERM: It is good practice to protect DC motors against sustained thermal overloads by fitting temperature sensitive resistors in the field and interpole windings of the machine. These devices have a low resistance (typically 200 ohms) up to a reference temperature (125°C) and above this their resistance rapidly increases to about 2 Kilohms. They should be wired in series and connected between 0 volts (terminal C1) and the thermistor input (terminal C2). A sensing circuit within the drive detects the change in resistance and produces a high logic level (Diagnostic 6) provided the resistance is low. The signal drops if the motor temperature exceeds 125°C and thereby quenches the drive.
- NOTE: This method of stopping the drive does not operate the three phase isolating contactor, it only phases back the firing pulses to give zero DC output to the armature. The drive may restart automatically when the motor temperature falls. Never work on the drive, motor, or ancilliary equipment without first isolating the main supply.
- 7) AUXILIARY ENABLE: Terminal C3 on the drive is normally connected to +24 volts at Terminal C4 to enable the drive to run. Alternatively C3 may be connected to +24 volts at Terminal C10 if latching of the Thermistor/microtherm, Field failure and external interlock alarms is required. Removing the signal from Terminal C3 will quench the drive.
- NOTE: That this method of stopping and starting the drive does not operate the three phase isolating contactor, it only phases back the firing pulses to give zero DC output to the armature. It should only be used for short term stops and never used if an operator can work on the motor or ancilliary equipment without tripping the contactor.
- 8) START INSTRUCTION: The Start/Stop instruction is applied through terminal C4 via

the external Start/Stop wiring. During the stop sequence, it is essential that the motor armature current is reduced to zero before the 3-phase isolating contactor is opened. This is achieved in the drive at switch off by a time delay (of approximately 50ms) before the contactor control relay is de-energised.

The start supply is taken from terminal C7 which is normally +24 volts. If excessive armature current levels are detected (400% for 3ms) an instantaneous latching trip is operated. This trip removes the Start Supply from terminal C7 thus quenching the drive and de-energising the contactor control relay. The 3-phase isolating contactor will open and Indicator 5 will extinguish. The start supply can only be re-established by the removal of all supplies (including the Auxiliary Supply) or by operating the Fault Reset\*.

- \* NOTE: The latching trips, (Trigger Fault and Overcurrent Fault) may also be externally reset by applying +24 volt to terminal C12 through a momentarily closed contact.

Only when all eight alarms are present is the Ready Output (terminal C8) switched to +24 volts.

#### ENABLE

An external Enable (terminal C5) is gated with the Ready Output to produce the final inhibit signal. The drive may therefore be held in a quench condition by removing the external Enable, although the 3-phase isolating contactor is still closed.

Terminal C5 must be externally connected to +24 volts before the final drive inhibit is removed and Indicator 6 is illuminated.

NOTE: That this method of stopping and starting the drive only phases back the firing pulses to give zero DC output to the armature. It should only be used for short term stops and never used if an operator can work on the motor or ancilliary equipment without tripping the contactor.

#### DRIVE OPERATIONAL

To enable rapid fault finding in multidrive systems each drive is provided with a Drive Operational output (terminal C10). When the drive is operational this output provides +24 volts to drive an externally connected relay and Indicator 8 is illuminated. If the drive becomes non-operational (ie. any alarm channel indicates a fault condition) Indicator 8 is extinguished and terminal C10 falls to 0 volts, after a short time delay.

The drive is always defined as operational when no start instruction is applied to terminal C7 (i.e. C10 will always be high under this condition). The drive will become non-operational when a start instruction is applied and any one of the alarm channels indicates a fault condition (i.e. if C7 is high but C8 is low).

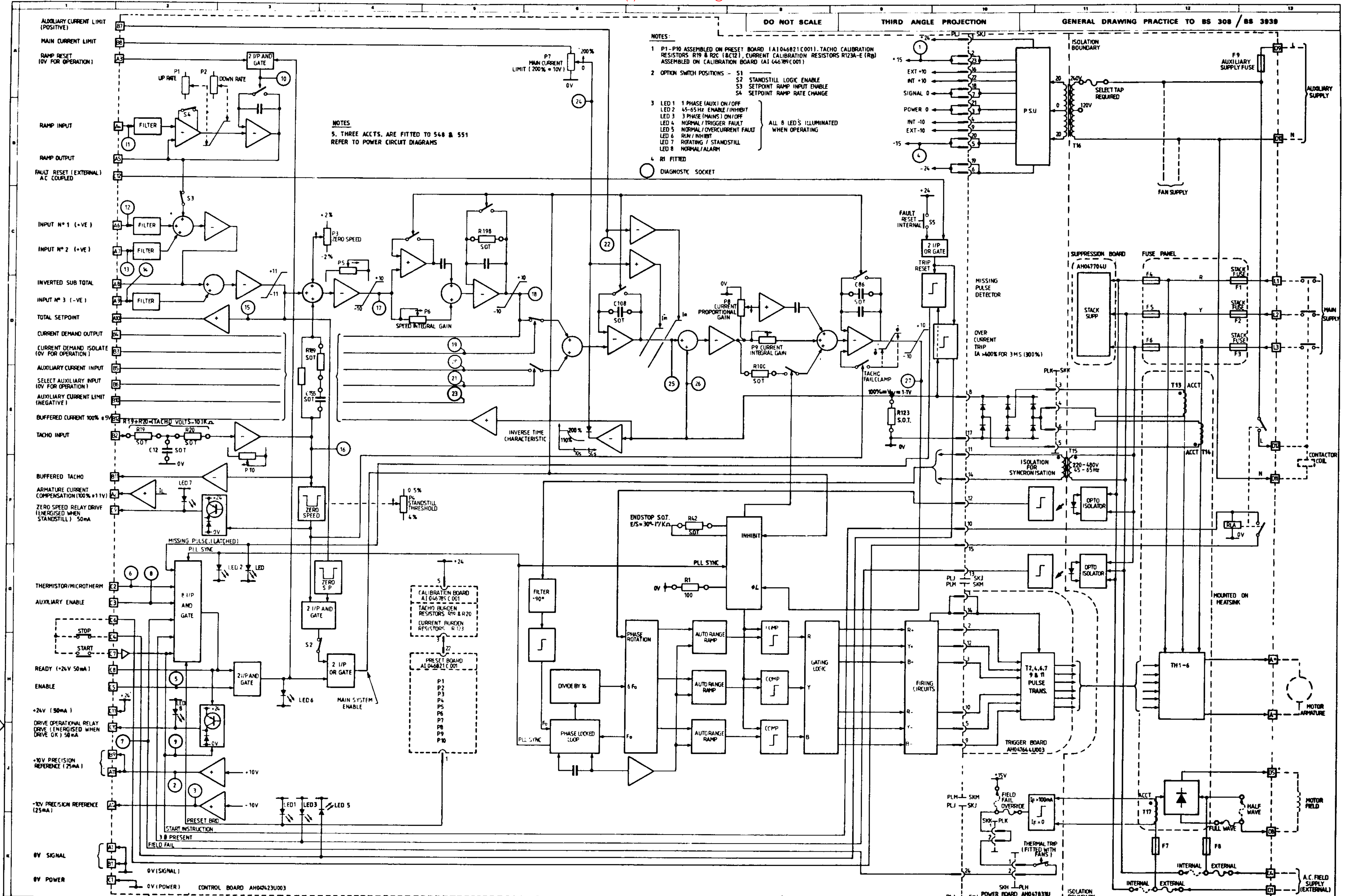

NOTES:  
1 P1-P10 ASSEMBLED ON PRESET BOARD (A1046821C001). TACHO CALIBRATION RESISTORS R19 & R20 (R121), CURRENT CALIBRATION RESISTORS R123A-E (R1) ASSEMBLED ON CALIBRATION BOARD (A1046821C001)  
2 OPTION SWITCH POSITIONS - S1 STANDSTILL LOGIC ENABLE  
S2 STANDSTILL INPUT ENABLE  
S3 SETPOINT RAMP INPUT ENABLE  
S4 SETPOINT RAMP RATE CHANGE  
3 LED 1 1 PHASE (AUX) ON/OFF  
LED 2 45-65 Hz ENABLE / INHIBIT  
LED 3 3 PHASE (MAINS) ON/OFF  
LED 4 NORMAL / TRIGGER FAULT  
LED 5 NORMAL / OVERCURRENT FAULT  
LED 6 RUN / INHIBIT  
LED 7 ROTATING / STANDSTILL  
LED 8 NORMAL / ALARM  
4 R1 FITTED  
5 THREE ACCTS. ARE FITTED TO 548 & 551 REFER TO POWER CIRCUIT DIAGRAMS

DO NOT SCALE THIRD ANGLE PROJECTION GENERAL DRAWING PRACTICE TO BS 308 / BS 3039

DATE 16-7-82 2-20-8-82 21-11-83 19-10-84	DRAWN D.J.H./M.R.E.	MATERIAL	DIMS. IN M.M. APPLY OVER FINISH (EXCEPT FOR PUNCH AND LACQUER)	ASSEMBLED ON	SCALE	TITLE 3 PHASE 2 QUADRANT BLOCK DIAGRAM 546
	CHECKED		GENERAL TOLERANCES: H ± 0.1, L ± 0.1, K ± 0.1, M ± 0.1, N ± 0.1, P ± 0.1, R ± 0.1, S ± 0.1, T ± 0.1, Y ± 0.1, Z ± 0.1			DRAWING NUMBER HH 048956 F
	DESIGN APPROVAL L.A.T.A.T.E.Y.	FINISH	INDICES: * 7mm, - 0.02 + 0.07			REV. 1 OF 1 SHEET
	MANUFACTURE APPROVAL					SSD Shackleton drives EI

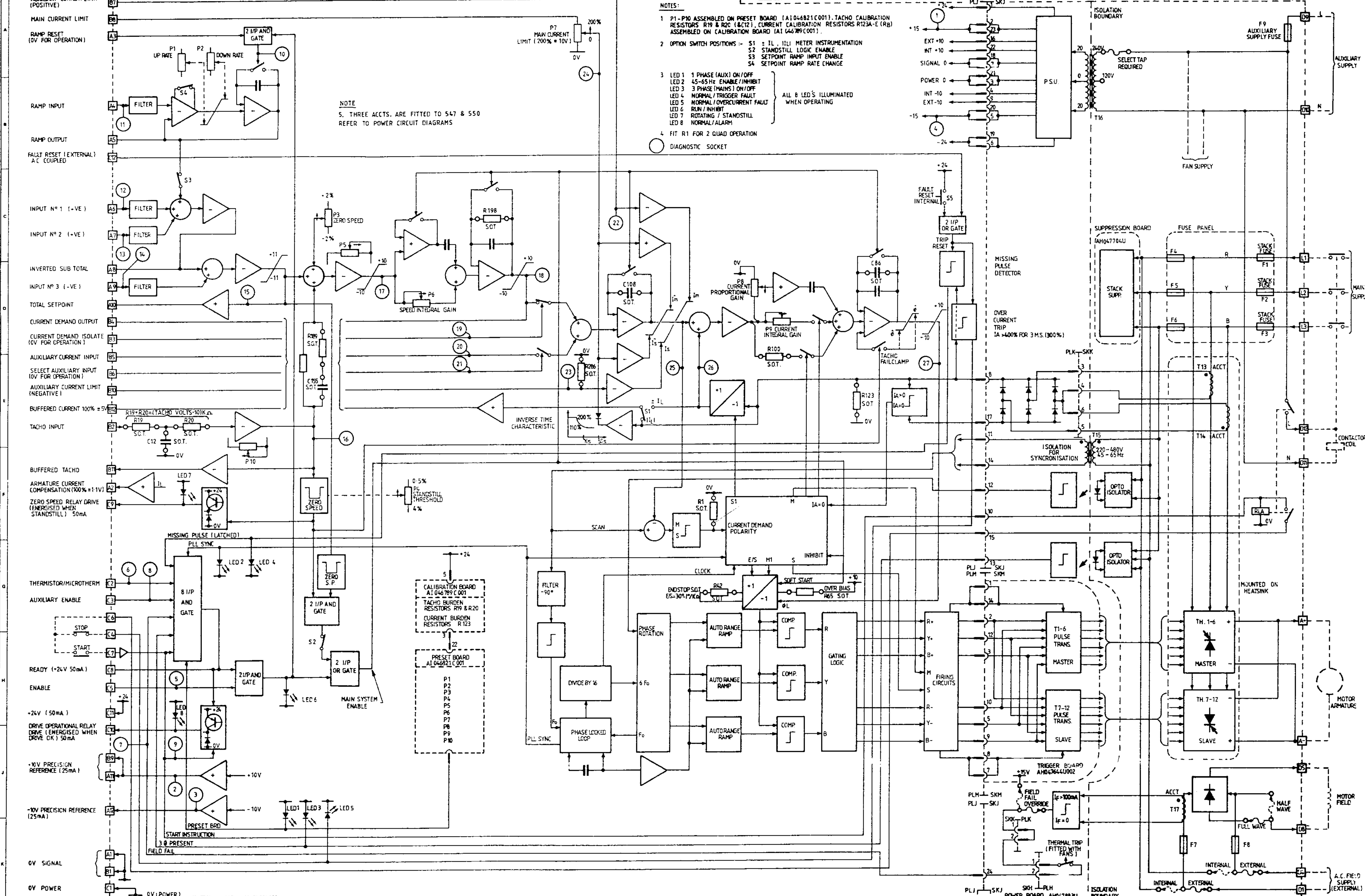

- NOTES:
- P1-P10 ASSEMBLED ON PRESET BOARD (A1046821C001). TACHO CALIBRATION RESISTORS R19 & R20 (& C12). CURRENT CALIBRATION RESISTORS R123A-E (R12) ASSEMBLED ON CALIBRATION BOARD (A104679C001).
  - OPTION SWITCH POSITIONS - S1 = IL, III METER INSTRUMENTATION  
 S2 STANDSTILL LOGIC ENABLE  
 S3 SETPOINT RAMP INPUT ENABLE  
 S4 SETPOINT RAMP RATE CHANGE
  - LED 1 1 PHASE (AUX) ON/OFF  
 LED 2 45-65 Hz ENABLE/INHIBIT  
 LED 3 3 PHASE (MANS) ON/OFF  
 LED 4 NORMAL / TRIGGER FAULT  
 LED 5 NORMAL / OVERCURRENT FAULT  
 LED 6 RUN /INHIBIT  
 LED 7 ROTATING / STANDSTILL  
 LED 8 NORMAL / ALARM
  - FIT R1 FOR 2 QUAD OPERATION
- DIAGNOSTIC SOCKET

NOTE  
 5. THREE ACCTS. ARE FITTED TO 547 & 550 REFER TO POWER CIRCUIT DIAGRAMS

DATE	DESCRIPTION
11-1-81	
8-2-82	
17-3-82	
16-7-82	
19-8-82	
2-1-83	
19-10-84	

DRAWN D.J.H./M.R.E.	MATERIAL
CHECKED	
DESIGN APPROVAL	FINISH
MANF. APPROVAL	

DIMS. IN M.M. APPLY OVER FINISH (EXCEPT FOR PAINT AND LACQUER)	
GENERAL TOLERANCES	HOLES <math>\phi</math> 7mm
X.X = ± 0.4	0.02 - 0.07
X.XX = ± 0.2	
X.XXX = ± 0.1	

ASSEMBLED ON

**Shackleton system drives**

SCALE

TITLE  
 3 PHASE 4 QUADRANT  
 BLOCK DIAGRAM 545

DRAWING NUMBER  
 HH 047422 F

SHT. 1  
 OF 1 SHTS

## BASIC SETTING UP AND OPERATING INSTRUCTIONS

### A. BEFORE ATTEMPTING TO CONNECT POWER:

#### CAREFULLY CHECK:

1. Auxiliary power supply voltage is correct.
2. Main power supply voltage is correct.
3. Armature voltage and current ratings.
4. Field option, voltage and current rating.
5. All external wiring circuits -
  - Power connections
  - Control "
  - Motor "

NOTE: Completely disconnect the controller before point to point checking with a buzzer or when checking insulation resistance with a megger.

6. For damage to equipment or wiring.
7. For loose ends, clippings, drilling chips, etc., lodged in the drive or electrical equipment.
8. Inspect the motor, in particular the commutator for any extraneous matter. If an air line is available it is recommended to blow over the commutator.  
 Check that the brushes are properly seated and that the brush spring tensions are adequate. If possible check that the motor (and vent fan motor when fitted) can be turned freely by hand.

#### ENSURE:

1. That rotation of the machinery in either direction will not cause a hazard.
2. That nobody else is working on another part of the equipment that can be affected by powering up.
3. That other equipment will not be adversely affected by powering up.

### B. PREPARATION:

1. Prevent the Main 3-phase power supply and single phase auxiliary supply from becoming connected to the drive by removing the main external HRC fuses.
2. Disconnect the load from the motor shaft if possible.
3. If there is any doubt about the integrity of a particular installation, insert a high wattage resistor i.e. fire elements, in series with the motor armature.
4. Check the tachogenerator calibration resistors and current calibration resistors on the small plug-in card which is accessible under the front cover.

NOTE: These resistors should be good quality 2% metal film type.

#### Tachogenerator calibration:

The two resistors R19 and R20 should be roughly equal in value and scaled as follows:

For full speed tacho voltages of up to 200 volts:

$$R19 + R20 = (\text{tacho volts} - 10)K \text{ Ohms}$$

For full speed tacho voltages greater than 200 volts, an external resistor, value RE, is required in series with the tachogenerator connection to terminal B2.

If the maximum values of R19 and R20 are fitted giving 190K total i.e. R19 = 120K R20 = 68K and R19 + R20 = 188K  $\approx$  190K, and assuming a burden of 50K. Then RE is given by the formula:-

$$RE = \frac{(\text{tacho volts} - 200)}{5} K \text{ Ohms}$$

The power dissipation of this resistor is given by the formula:-

$$RE = (\text{tacho volts} - 200) \times 5 \text{ milliwatts.}$$

#### DCVT Calibration:

Where DCVT feedback is used instead of tacho feedback (i.e. Product Code block 9 = 13), R19 and R20 should be roughly equal in value and should be selected according to the formula:

$$R19+R20 = (\text{Full speed DCVT output} - 1)K \text{ Ohms.}$$

#### Full load armature current calibration:

Armature current is scaled by resistors R123 A,B,C,D and E. The combined value of all these resistors in parallel should be calculated as follows:

$$R123 = \frac{2200}{(\text{Full Load Amps} - 1)} \text{ Ohms}$$

NOTE: The armature current calibration should NEVER be changed to increase the current above the factory set value without prior consultation with SSD Ltd.

5. Check the preset potentiometer settings on the larger plug-in card which is accessible under the front cover. The potentiometers are normally factory set to positions which will provide adequate performance in most load/controller configurations. It is recommended that initially the presets are left in these positions and that fine tuning of the system is done, if necessary, at the end of the commissioning process. The one exception to this is the main current limit preset; note the setting of this control and then turn it fully anticlockwise. The initial setting of the presets should thus be as follows:

Pot No.	Description	Normal Initial Setting
1.	<u>Setpoint ramp up rate</u> Clockwise rotation gives more rapid acceleration.	Midway
2.	<u>Setpoint ramp down rate</u> Clockwise rotation gives more rapid deceleration.	Midway
3.	<u>Zero speed</u> It should not be necessary to adjust this initially on a new factory tested drive.	About midway
4.	<u>Standstill threshold</u> Sets low speed drive quench level if the standstill logic switch is set to position 1. Clockwise sets lower speed.	Midway

- |  |  |
|--|--|
| 5. <u>Speed proportional</u><br>Clockwise increases<br>speed loop gain   | 20%<br>Clockwise                                 |
| 6. <u>Speed Integral</u><br>Clockwise decreases<br>speed loop integral<br>time constant                              | 20%<br>Clockwise                                 |
| 7. <u>Main Current Limit</u><br>Clockwise increases<br>current limit up to<br>max. 200% FLC* short-<br>term overload | Fully<br>anti-<br>clockwise<br>(zero<br>current) |
| 8. <u>Current Proportional</u><br>Clockwise increase<br>current loop gain  | Midway   |
| 9. <u>Current Integral</u><br>Clockwise decreases<br>current loop integral<br>time constant                          | Fully<br>anti-<br>clockwise                      |
| 10. <u>Speed Calibration</u><br>Clockwise increases<br>motor speed   | About<br>midway                                  |

\* Full Load Current.

#### 6. Set Option Switch

This is a small 4-toggle (DIL) switch located on the main control board near to the left-hand end of the diagnostic socket. To access the switch it is necessary to remove the push-on protective panel attached to the Main Control printed circuit board.

#### SWITCH S1: Buffered Current Signal (terminal B12)

UP = ON = Armature current meter reads  $\pm$  Amps. For applications employing a centre-zero meter.

DOWN = OFF = Meter reads modulus. For applications employing a uni-directional meter.

#### NOTE:

In 546 and 548 units the Armature Current Meter will always read +Amps, regardless of the setting of switch S1, since these convertors cannot produce negative output current.

#### Switch S2: Standstill Logic

UP = ON = Standstill logic enabled. This will disable the drive whenever the Total Setpoint is zero and the speed is below the standstill threshold set by P4.

DOWN = OFF = Standstill logic inoperative

#### Switch S3: Setpoint Ramp Connection

UP = ON = Setpoint Ramp Output internally summed with Input No.1 and Input No.2.

DOWN = OFF = Setpoint Ramp Output internally disconnected from the summing amplifier (but still available at terminal A5.)

#### Switch S4:

UP = ON = Setpoint ramp rate adjustable from 0.25 to 7.5 seconds.

DOWN = OFF = Setpoint ramp rate adjustable from 2.5 to 75 seconds.

For most applications the switches would be set as follows:

S1 set UP (ON) = Current meter reads  $\pm$ .

S2 set DOWN (OFF) = Standstill logic inoperative.

S3 set UP (ON) = Setpoint ramp connected.

S4 set DOWN (OFF) = Setpoint ramp adjustable from 2.5 to 75 seconds.

7. Plug a Diagnostic Test Unit type 5570 into the socket on the control printed circuit board, observing correct orientation of the connector (see Diagnostic Test Facility, section C). This unit is not essential to the successful commissioning of a drive but it very much simplifies the procedure and can save a considerable amount of time.

### C. CHECKING THE DRIVE AND SETTING UP:

1. When all the preceding steps are completed the auxiliary power supply can be connected to terminals D9 and D10, (but do not connect the Main 3-phase power supply at this stage). Immediately check that the correct voltage appears between D9 and D10.

2. Now check:

- i) The drive condition indicators - these are eight LED lamps at the lower right-hand corner of the Main Control printed circuit board. LED No's 1, 4, 5 and 8 should be on.
- ii) Check the +24v (nominal) supply at terminal C11 (with respect to C1) to be between 22 and 30 volts.
- iii) If a Diagnostic Test Unit (5570) is available, check the  $\pm 15$ v supplies at switch positions 1 and 4.
- iv) Check the +10v supply rail:  
Switch to diagnostic test point 2 or measure the voltage between terminals A11 (+10V) and A1 (0v).
- v) Check the -10v supply rail:  
Switch to diagnostic test point 3 or measure the voltage between terminals A12 (-10v) and A1 (0v).

3. If a Diagnostic Test Unit is available, check that all other test point readings are as shown in Diagnostic Chart 3.

4. Check that a speed demand signal is available. This will normally appear as an input to the Setpoint Ramp on terminal A4 (diagnostic test point 11).

Additional setpoint inputs may also appear at:

Input No. 1 (+), terminal A6 (Diag. 12)

Input No. 2 (+), terminal A7 (Diag. 13)

Input No. 3 (-), terminal A9 (Diag. 14)

NOTE:

The sum of the setpoint voltages appears at terminal A10 (Diagnostic 15) as the Total Setpoint voltage.

5. If possible, check the polarity of the tachogenerator signal by rotating the motor shaft manually in the "forward" direction (ie: the direction which should correspond to a positive setpoint at A4):

The voltage at terminal B2 (or B11) should go positive.  
The voltage at Diagnostic test point 16 should go negative.

6. Press the "Drive Start" pushbutton or otherwise initiate START:

The Main 3-phase contactor should pull in and latch via the control relay within the drive.

Press the "Drive Stop" pushbutton or otherwise initiate STOP:

The main contactor should drop out, de-energised. If not disconnect all power supplies and check the Stop/Start circuit and contactor wiring.

NOTE:

The main contactor should NEVER be operated by any means other than the drive internal contactor control circuit as shown in the wiring diagram HJO4794OD.

WARNING:

**DO NOT PROCEED FURTHER UNLESS THE STOP/START CIRCUITS AND CONTACTOR OPERATE CORRECTLY.**

7. Turn off all power supplies to the equipment and when the whole system is totally isolated and safe, reconnect the Main 3-phase power supply.
8. Turn on Auxiliary single phase supply.
9. Turn on Main 3-phase supply.
10. Turn the Speed Setpoints to zero so that the Total Setpoint voltage is zero (terminal A10, Diagnostic 15).
11. Check that the Main Current Limit preset (P7) is set to zero (fully anticlockwise).
12. Initiate "Drive Start" and immediately check that the correct field voltage appears between terminals D5 and D8. Note that this will be high voltage DC, so proceed with extreme caution. Do not continue if this is not correct, but switch off all supplies and recheck the Product Code.  
Check that the motor ventilation fan, if fitted, is rotating in the correct direction. Check the direction visually as the fan starts since a centrifugal fan may produce considerable air flow even when rotating in the wrong direction.
13. Check that all Drive Condition Indicators except LED 7, are lit. Refer to the Diagnostic section for explanation of the LED functions. In

particular note that any exterior interlocks in the Enable and Auxiliary Enable circuits will affect the conditions of LED's 6 and 8.

14. Check that the Standstill Logic is switched OFF (Option Switch 2).

NOTE:

- (a) During the following stages (15 and 16) be ready to stop the drive immediately should the motor try to overspeed.
- (b) Before altering any connections make sure that all Auxiliary and Main power supplies are totally isolated from the drive and equipment and that the motor is stationary.

15. Adjust the Speed Setpoint so that the Total Setpoint voltage is about 0.5 volts (terminal A10, Diagnostic 15).  
Slowly increase the Main Current Limit setting up to about 20% FLC (i.e. not more than 1 volt at Diagnostic test position 24). Since the Total Setpoint is set to 0.5V the motor speed should increase to only 5% of full speed. If this speed is exceeded, reversed connection of the tacho or field is implied, quickly turn the Main Current Limit (P7) to zero (anticlockwise).  
Disconnect all supplies and reverse either the field or tacho connections, then reconnect the supplies and repeat the test. If the motor still runs out of control check the tacho and the continuity of its wiring. Proceed only when this test is satisfactorily completed.

16. With the Main Current Limit (P7) set to about 20% FLC slowly increase the Total Setpoint voltage to +1 volt (terminal A10, Diagnostic 15). The motor should now run at about 10% Full Speed and LED 7 should light.

NOTE:

When correctly connected and operating normally at constant speed the Speed Feedback voltage (Diagnostic 16) will be equal to the Total Setpoint voltage (Diagnostic 15) but of opposite polarity. Under these conditions the Speed Error voltage (Diagnostic 17) will be zero. If this condition cannot be achieved, the system is probably in current limit (this is most likely at this stage if the load is coupled to the motor). Increase the setting of the Main Current Limit (P7) slowly until motor accelerates to the set speed and the Speed Error signal falls to zero.

17. Check the motor direction; if it is incorrect disconnect all supplies and reverse both tacho and field connections.
18. 545 and 547 drives only:  
Adjust the Total Setpoint voltage to about -1V and check that the motor runs in control in the reverse direction.
- 19a. 545 and 547 drives:

Set the Speed Setpoint to zero and adjust the Speed Zero preset potentiometer (P3) for minimum shaft creep. (Alternatively the

Speed Zero potentiometer may be used to adjust the balance of maximum speed in forward and reverse directions).

19b. 546 and 548 drives:

Set the Speed Setpoint to zero. Turn the Speed Zero preset potentiometer (P3) clockwise until the motor shaft turns, then back-off P3 until the shaft just stops turning.

20. Gradually increase the Speed Setpoint to maximum and check that the shaft speed is nominally correct. If fine adjustment of the top speed is required, the Maximum Speed potentiometer (P10) provides  $\pm 10\%$  trim.

NOTE:

If the load is connected to the motor it may be necessary to increase the Main Current Limit control (P7) setting to achieve full speed.

21. 545 and 547 drives only:

Reverse the Speed Setpoint and check the maximum reverse speed.

22. Reset the Main Current Limit (P7) to its original position, which was noted in part B5 of this procedure. If in doubt set the control (P7) to 60% clockwise rotation (6V measured at Diagnostic 24) corresponding to a maximum armature current of 1.2 times Full Load. Fully clockwise rotation of P7 (10v measured at Diagnostic 24) corresponds to an armature current level of twice full load.

Note that if the drive runs into an overload condition, the current is automatically reduced on an inverse time characteristic back to 110% of full load. If the overload facility is not required, the Main Current Limit potentiometer (P7) should be turned progressively anticlockwise, almost to the midway position - this will limit the current to just above Full Load.

D. RUNNING PERFORMANCE ADJUSTMENTS:

1. Disconnect all supplies and connect the motor to its load. Set the speed setpoint to zero, reconnect the supplies and switch on. Increase the speed setpoint and check that the drive runs smoothly under load; the speed should be stable and the armature current should be steady.

The Proportional and Integral potentiometers (P5, P6, P8 and P9), as preset by SSD, will provide stable and responsive performance under most load conditions. Thus if instability is observed it is important to first check the load and couplings:

If there is a cyclic variation of the armature current check the mechanical couplings to the load - this is a common cause of apparent instability in either the speed or motor current. If speed instability is present check whether the repetition rate of the instability is related to any of the mechanical revolution rates of the load - if it is the instability frequency will vary with speed. This form of instability may

be reduced by adjustment of the drive presets, but total elimination of the problem may require improvement of the load characteristics.

2. Instability due to incorrect setting of the drive control parameters can occur and is recognisable because its frequency will be relatively independent of the drive speed. If this form of instability is present, or if the application demands that the drive is trimmed for optimum response, then the stability controls may be adjusted as follows. Note that while the speed stability and response may be improved without the use of a Diagnostic Unit or Oscilloscope it is difficult to optimise the current response without such instrumentation. Consequently, the following procedure assumes that both instruments are available.

3. Current Loop Adjustment (P8 and P9)

With all power supplies disconnected, disconnect the field wires from terminals D5 and D8, labelling each wire clearly so that it can later be reconnected with the correct polarity. Transfer the "Field Fail" plug to the "Override" position on the Power Supply printed circuit board.

NOTE:

- (i) It is now possible to operate the drive in a stalled condition. Great care must be taken not to damage the motor by overheating. If the motor is fitted with a force ventilation fan arrange that it is connected and running during the test. In any case DO NOT remain in the stalled condition for long periods.
- (ii) Although the field supply is disconnected the motor may still produce some torque due to residual or compound field flux. It is essential therefore, to mechanically lock the motor shaft, or apply sufficient load to prevent rotation during the following procedure.

4. To achieve Full Load Current it is necessary to override the Tacho Failure Alarm/Clamp: Disconnect the Tacho(+) wire from terminal B2 and then link terminal B2 to  $\pm 10V$  (terminal A11, A12 or B9).

5. The optimum setting of the Current Proportional and Integral presets (P8 and P9) depends, to some extent, on the setting of the Main Current Limit (P7). Thus P7 should be correctly adjusted to suit the load, before adjustment of P8 and P9 is attempted.

6. When the Main Current Limit control is correctly set, proceed as follows:

If the Speed Setpoint is applied via the Setpoint Ramp, set the Ramp Rate presets P1 and P2 fully clockwise and Option Switch S4 UP (ON), to provide the fastest ramp rate. Set the Speed Proportional and Integral presets (P5 and P6) fully clockwise to provide the fastest rate of change of Current Demand signal (observable at Diagnostic 25).

Connect the Diagnostic Unit to the Control printed circuit board (accessed via the outer

cover - observe correct orientation of plug into the socket). Connect the Oscilloscope to the output sockets on the Diagnostic Unit and switch to Diagnostic 26. This provides access to a safe, isolated signal representing the armature current waveform where  $\pm 1.1v = \pm 100\%$  full load current.

7a. 545 and 547 drives:

Reconnect the supplies and switch on. Observe the armature current waveform while changing the polarity of the Current Demand signal (by varying the Speed Setpoint). With each change of Current Demand polarity the current should increase rapidly, but without overshoot and then remain steady. If necessary adjust P8 and P9 slowly to obtain a Critically Damped performance, ie. the fastest response possible without overshoot, as shown in Figure 3 below. Figures 1 and 2 show typical armature current waveforms where P8 and P9 are incorrectly set and indicate the adjustment required to improve the drive performance, to conform with that of Figure 3.

In general, clockwise rotation of the presets will improve the speed of response, but rotating the controls too far will tend to introduce overshoot.

7b. 546 and 548 drives:

Reconnect the supplies and switch on. While observing the armature current waveform, suddenly increase the Current Demand signal by rapidly increasing the Speed Setpoint from zero to +10V (then reduce the Setpoint to zero again; note that the armature current will return more rapidly to zero if the Speed Zero preset is set anticlockwise). With each increase of Current Demand the current should increase rapidly, but without overshoot and then remain steady. If necessary adjust P8 and P9 slowly to obtain a Critically Damped performance, ie. the fastest response possible without overshoot, as shown in Figure 3\*.

Figures 1\* and 2\* show typical armature current waveforms where P8 and P9 are incorrectly set and indicate the adjustment required to improve the drive performance, to conform with that of Figure 3\*.

In general, clockwise rotation of the presets will improve the speed of response, but rotating the controls too far will tend to introduce overshoot.

\* Note that in 546 and 548 non-regenerative drives the current waveform will increase from zero instead of the negative value shown in the figures.

8. When the Current Loop response adjustment is completed, switch off the drive and disconnect all supplies.

REMOVE THE LINK FROM BETWEEN TERMINAL B2 AND THE 10V SUPPLY AND THEN RECONNECT THE TACHO(+) WIRE TO TERMINAL B2.

Transfer the "Field Fail" plug back to its original position and reconnect the field wires to terminals D5 and D8, ensuring that they are replaced in their original positions i.e. with correct polarity. Remove any mechanical devices previously used to lock the motor shaft.

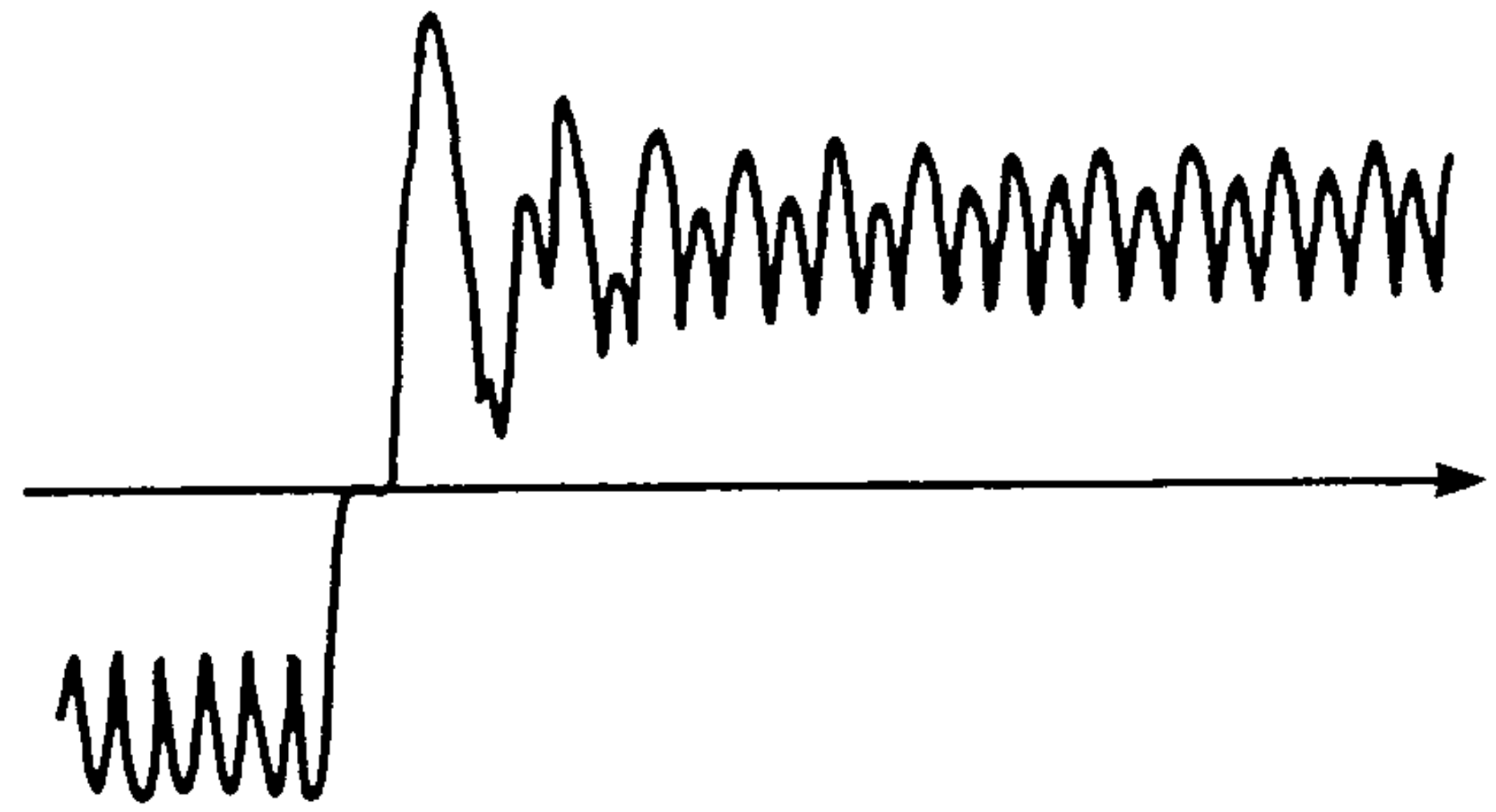

FIGURE 1. ARMATURE CURRENT WAVEFORM:  
Current Loop controls incorrectly set - Integral Time Constant too short - increase Current Loop Integral Time Constant by rotating P9 anticlockwise.

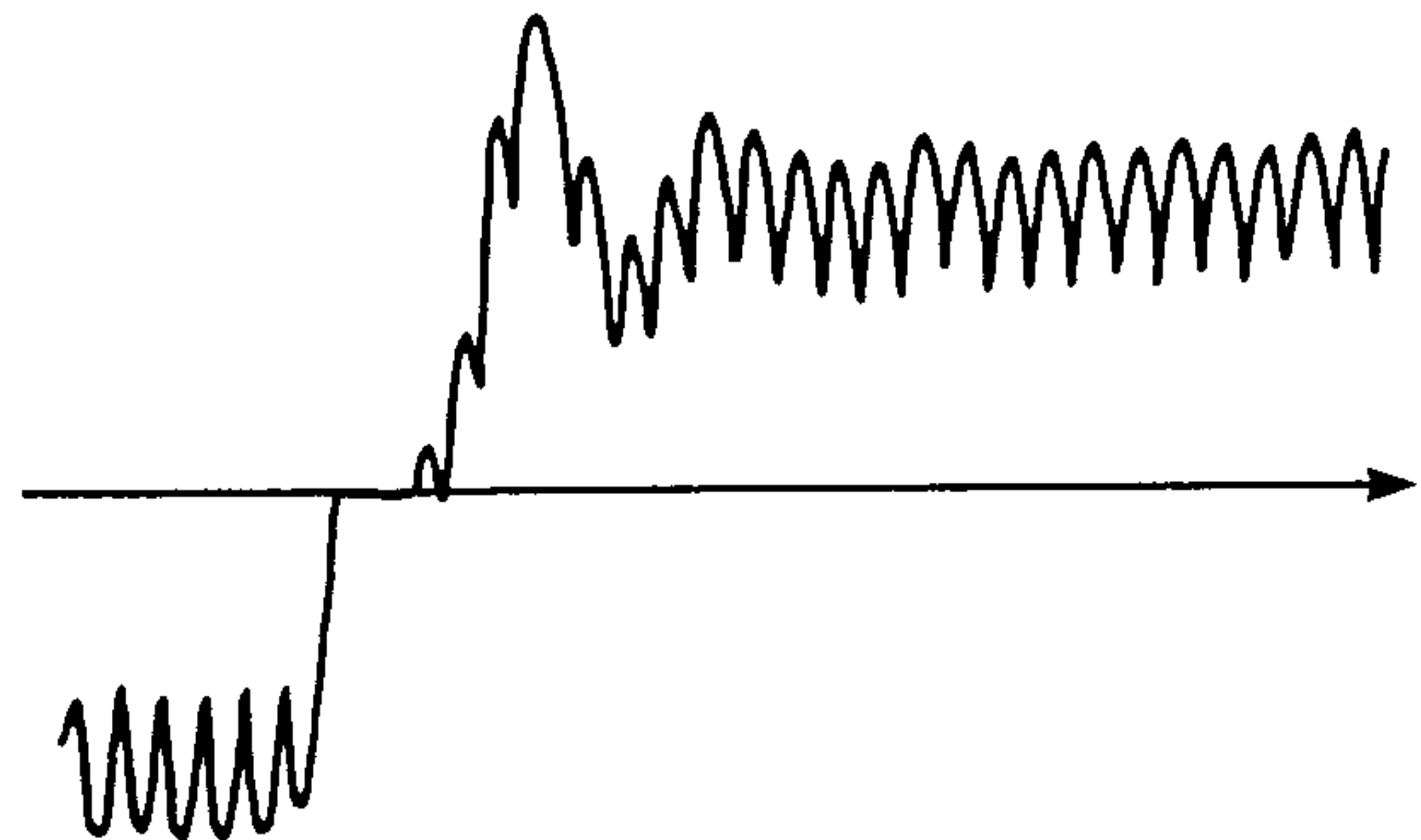

FIGURE 2. ARMATURE CURRENT WAVEFORM:  
Current Loop controls incorrectly set - Proportional Gain too low - increase Current Loop Proportional Gain by rotating P8 clockwise.

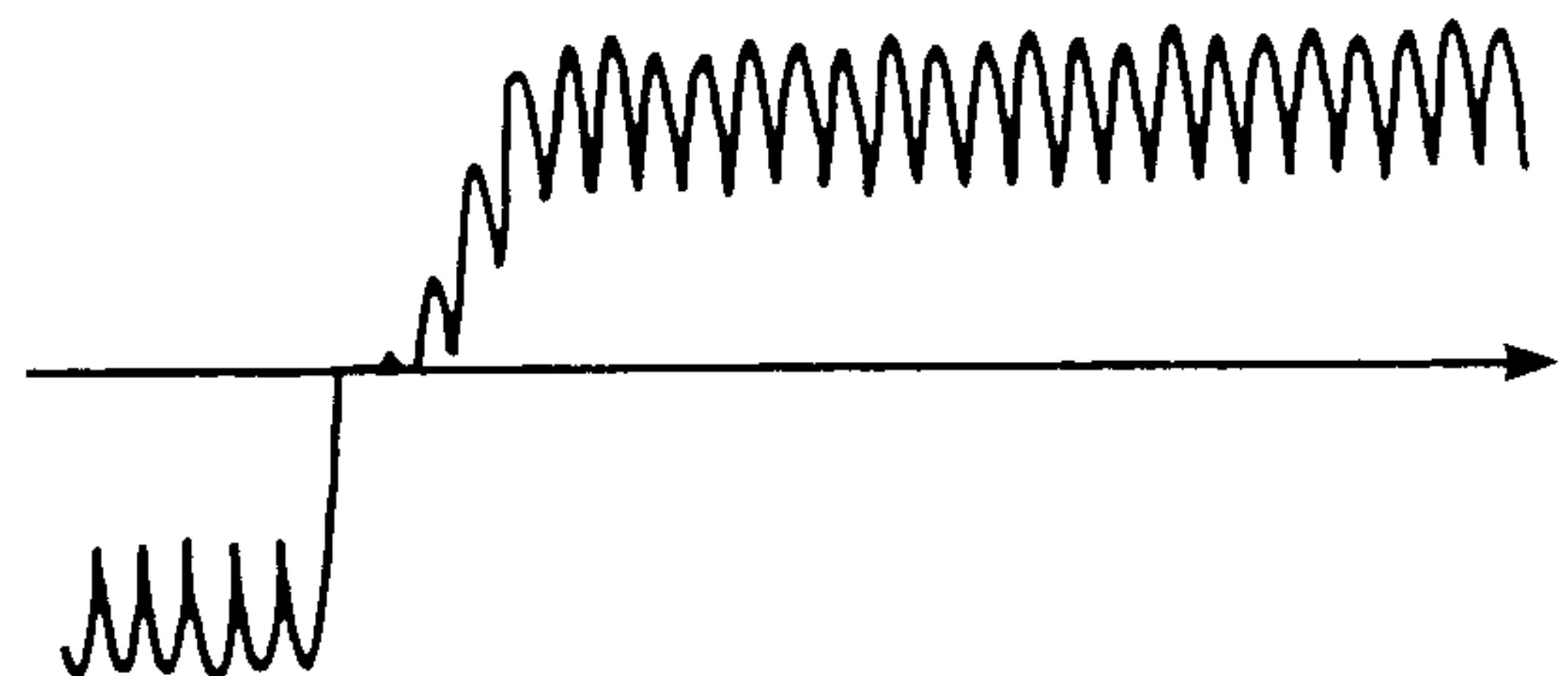

FIGURE 3. ARMATURE CURRENT WAVEFORM:  
Current Loop Response (P8 & P9) correctly adjusted.



9. Speed Loop Adjustment (P5 and P6)

If the Speed Setpoint is applied via the setpoint ramp turn P1 and P2 fully clockwise and switch S4 UP (ON). Set the Speed Setpoint to zero. Switch the Diagnostic Unit to position 16 so that the Oscilloscope displays the scaled Tacho Feedback signal ( $\pm 10v = \pm$  full speed).

10. Reconnect the supplies and initiate Start. Apply a small step change (about 20%) to the Speed Setpoint input and observe the speed response. If necessary adjust the Speed Proportional and Speed Integral presets (P5 and P6) gradually to obtain a Critically Damped performance i.e. the fastest response possible without overshoot, as shown in Figure 4, Curve (c). In general, clockwise rotation of the presets will improve the rate of response, but advancing the controls too far will tend to introduce overshoot. The optimum setting of P5 and P6 will be a compromise between the two extremes shown in Curves (a) and (b), Figure 4.
11. When the Speed Loop adjustment is completed reset Option Switch S4 to its original position.
12. If the Speed Setpoint is applied via the Setpoint Ramp, then the acceleration and deceleration rates of the drive, in response to a change of input, are individually adjustable

by the Positive and Negative Rate presets, P1 and P2. The fastest rates are achieved by setting the controls fully clockwise. The range of the potentiometers can be selected by Option Switch S4 to be either 0.25 to 7.5 seconds or 2.5 to 75 seconds to Full Speed.

13. Reset Option Switch S2 (Standstill Logic) to its original position. Note that if it is desired to eliminate shaft creep at zero setpoint in 545 and 547 regenerative drives then this switch should be set to the UP (ON) position. This provides a "deadband" about zero speed which is adjustable by the Standstill Threshold preset (P4) over the range  $\pm 0.5$  to  $\pm 4\%$  of Full Speed. The armature current will be totally interrupted when the shaft speed is within the band set by P4 and the Total Setpoint voltage is zero, at any other time the drive will operate normally.

NOTE:

The setting of the Zero Speed preset P3 will effect the symmetry of operation of the Standstill Logic about zero.

14. The drive should now be ready to operate. It is now essential to check the remaining control circuitry for correct operation. In particular, check that all Emergency Stop buttons and external interlocks work efficiently.

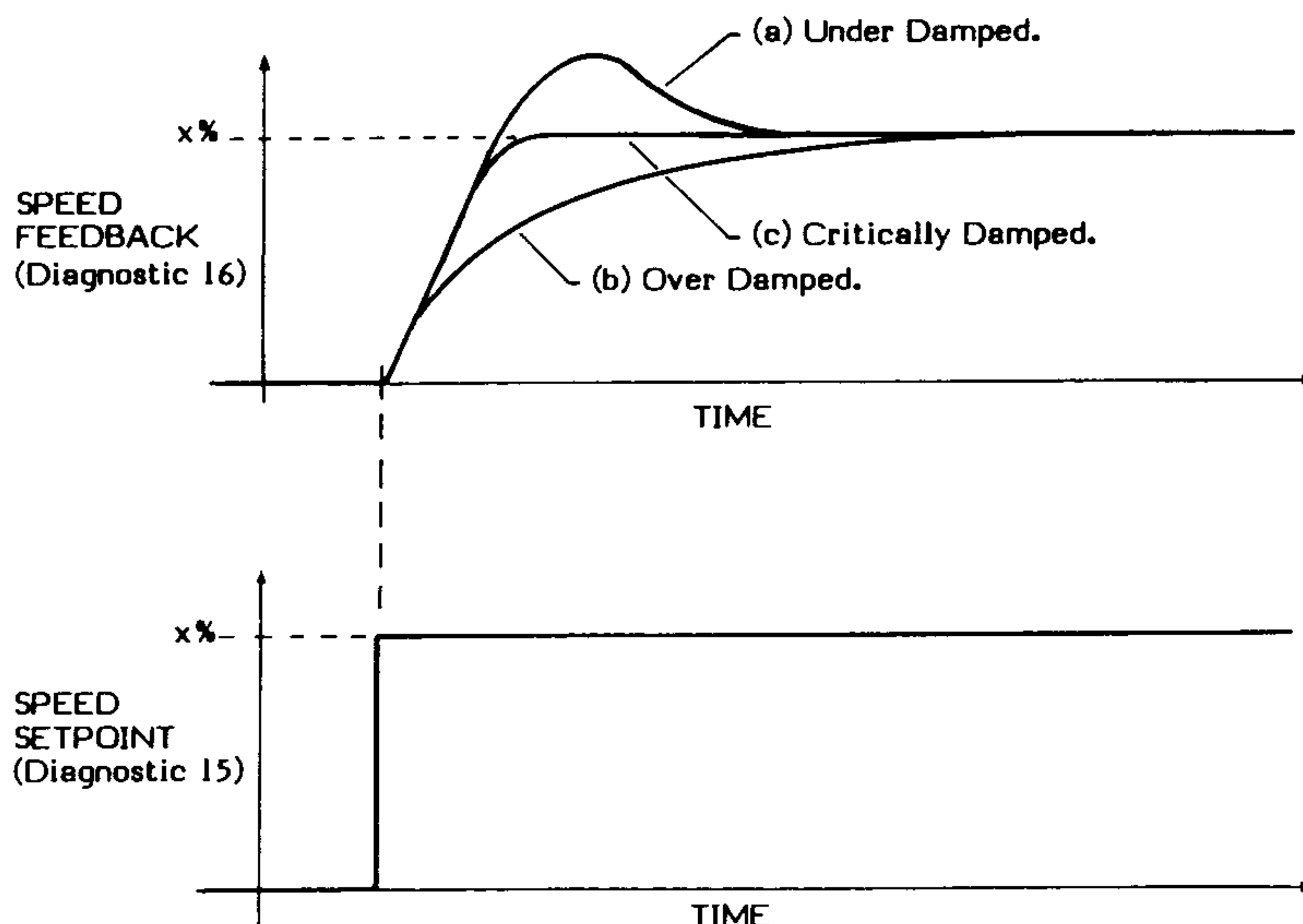

FIGURE 4. TYPICAL SPEED RESPONSE CURVES.

## DIAGNOSTIC TEST FACILITY

### A. DESCRIPTION OF DIAGNOSTIC TEST UNIT

The drive is fitted with a multi-pin socket near the lower edge of the Main Control printed circuit board to allow connection of a type 5570 Diagnostic Test Unit.

The Diagnostic Test Unit is a small, portable, plug-in module which when connected to the drive provides access via a selector switch to 27 internal test points. The unit incorporates the following features.

1. A digital voltmeter to permit accurate measurement of steady state signals.
2. An analog voltage "Trend indicator" in the form of a row of LED displays which span signal levels in the range  $\pm 10V$ . This is a fast responding indicator which shows the magnitude of rapidly changing signals.
3. A pair of output sockets (standard 4mm) to enable signals to be monitored externally on an oscilloscope.

Under normal operating conditions, all signals which appear on the Diagnostic Test Unit are isolated from the main power supplies and field and armature circuits.

On certain models of drive in the 540 series the Diagnostic Test Unit is also available as a built-in feature.

### B. DIAGNOSTIC TEST PROCEDURE

The Diagnostic Test Unit should always be used in conjunction with the drive condition indicators located on the main control printed circuit board.

In attempting to determine causes of fault conditions it is essential to follow the normal setting up procedure for the drive as set out in the appropriate sections of this manual.

If you reach a stage in the set-up procedure where the required conditions are not satisfied:

#### FIRST

Look at the DRIVE CONDITION INDICATORS and refer to the Indicator Description Chart (Diagnostic Chart 1)

#### SECOND

Look at the DRIVE CONDITION INDICATORS and compare with the Status Recognition Chart (Diagnostic Chart 2)

#### THIRD

Check the voltage indicated by the 5570 DIAGNOSTIC TEST UNIT and compare with the Voltage Measurement Chart (Diagnostic Chart 3)

### C. CONNECTION AND DISCONNECTION OF THE DIAGNOSTIC TEST UNIT

#### CONNECTION:

1. Disconnect the Auxiliary and Power Supplies from the drive.
2. Push back the Retainer/Ejector Lever at each end of the Control PCB Socket.
3. Insert the Diagnostic Unit Plug into the Socket, ensuring that Polarising Tab and Slot are correctly aligned. The Retaining Clips should close automatically as the Plug is pushed home.

#### DISCONNECTION:

1. Disconnect the Auxiliary and Power Supplies from the Drive.
2. Push back both Retainer/Ejector Levers, balancing the pressure applied so that the Plug is ejected without tilting.

## DIAGNOSTIC CHART 1

### DRIVE CONDITION INDICATORS - DESCRIPTION

#### LED 1: 1 PHASE (AUXILIARY SUPPLY) ON/OFF

- ON: Single phase auxiliary supply on.
- OFF: a) Single phase supply or fuse FS9 failed.
- b) Presets PCB or Calibration PCB not fitted or plugged in correctly.

#### LED 2: 45-65 HZ ENABLE/INHIBIT

- ON: Phase locked loop synchronized.
- OFF: Phase locked loop not synchronized to main 3-phase power supply.

#### LED 3: 3-PHASE POWER SUPPLY

- ON: 3-Phase power supply connected
- OFF: a) 1 Phase or more not connected.
- b) Main contactor not closed.
- c) Main fuse failure check FS1, FS2, FS3.
- d) Coding fuse failure check FS4, FS5, FS6.

#### LED 4: NORMAL/TRIGGER FAULT

- ON: Armature Current waveform normal
- OFF: Abnormal current waveform detected indicating failure of an SCR to trigger or turn on. The drive can only be restarted after such a fault occurs by either pressing the "FAULT RESET" pushbutton or externally by applying +24V (from terminal C11) to reset terminal C12.

#### LED 5: NORMAL/OVER CURRENT FAULT

- ON: Armature Current Normal
- OFF: Armature Current has exceeded 300% full load. In this condition the main contactor will be automatically tripped. The entire system must be checked thoroughly to ascertain the cause of the failure. The drive can be restarted after such a fault by either pressing the "FAULT RESET" pushbutton or externally by applying +24V (from terminal C11) to terminal C12.

#### LED 6: RUN/INHIBIT

- ON: Indicates that both "READY" signal (on terminal C8) and "ENABLE" signal (on terminal C5 and diagnostic 5) are present. The drive will now start.
- OFF: Either "READY" or "ENABLE" signals have been removed.

#### NOTES:

- a) The "READY" signal depends upon each of the following signals being in its enabled condition:
- i) Single phase (auxiliary supply) On/Off (LED 1)
  - ii) 45-65HZ Enable/Inhibit (LED 2)
  - iii) 3-Phase (Main Supply) On/Off (LED 3)
  - iv) Normal/Trigger Fault (LED 4)
  - v) Motor Thermistor/Microtherm (DIAGNOSTIC 6)
  - vi) Field Fail (DIAGNOSTIC 7)
  - vii) Auxiliary Enable (DIAGNOSTIC 8)
  - viii) Start Instruction (DIAGNOSTIC 9)
- b) The "ENABLE" signal depends on the external connection of +24V (Nominal) to Enable terminal C5, normally from START SUPPLY terminal C4. START SUPPLY is only present when LED 5 is lit.

#### LED 7: ROTATING/STANDSTILL

- ON: Indicates the motor shaft is rotating. (Speed signal exceeds STANDSTILL THRESHOLD set by potentiometer P4. Adjustment range 0.5 to 4%).
- OFF: Motor shaft speed is less than standstill threshold.

#### LED 8: NORMAL/ALARM

- ON: Drive condition normal.
- OFF: Drive in fault condition.

#### NOTES:



- a) In the STOP condition the "NORMAL" signal only requires that the internal supply rails are present.
- b) In the START condition the "NORMAL" signal requires the READY signal (terminal C8) to be present.

## DIAGNOSTIC CHART 2



### DRIVE CONDITION INDICATORS - STATUS RECOGNITION

CONDITION REFERENCE								<u>STOP CONDITION</u>	
1 PHASE (AUX) ON/OFF								<div style="display: flex; flex-direction: column; align-items: center;"> <div style="display: flex; align-items: center; margin-bottom: 5px;"> <div style="width: 15px; height: 15px; background-color: black; border-radius: 50%; margin-right: 5px;"></div> LED ON                 </div> <div style="display: flex; align-items: center; margin-bottom: 5px;"> <div style="width: 15px; height: 15px; border: 1px solid black; border-radius: 50%; margin-right: 5px;"></div> LED OFF                 </div> <div style="display: flex; align-items: center;"> <div style="width: 15px; height: 15px; border: 1px solid black; border-radius: 50%; position: relative; margin-right: 5px;"> <span style="position: absolute; top: 50%; left: 50%; transform: translate(-50%, -50%); font-size: 8px;">X</span> </div> EITHER                 </div> </div>	
45-65 HZ ENABLE/INHIBIT									
3-PHASE (MAINS) ON/OFF									
NORMAL/TRIGGER FAULT									
NORMAL/OVERCURRENT FAULT									
RUN/INHIBIT									
ROTATING/STANDSTILL									
NORMAL/ALARM									
	1	2	3	4	5	6	7	8	CONDITIONS/CHECKS
A	<input checked="" type="checkbox"/>	<input type="checkbox"/>	<input type="checkbox"/>	<input checked="" type="checkbox"/>	<input checked="" type="checkbox"/>	<input type="checkbox"/>	<input type="checkbox"/>	<input checked="" type="checkbox"/>	NORMAL STOP CONDITION.
B	<input type="checkbox"/>	<input type="checkbox"/>	<input type="checkbox"/>	<input type="checkbox"/>	<input type="checkbox"/>	<input type="checkbox"/>	<input type="checkbox"/>	<input type="checkbox"/>	NO AUXILIARY SUPPLY.  CHECK: (1) Auxiliary A.C. supply voltage on terminal D9 with respect to terminal D10 corresponds to auxiliary power supply transformer tapping selected on power board. (2) Auxiliary supply fuse F9.
C	<input type="checkbox"/>	<input type="checkbox"/>	<input type="checkbox"/>	<input checked="" type="checkbox"/>	<input checked="" type="checkbox"/>	<input type="checkbox"/>	<input type="checkbox"/>	<input checked="" type="checkbox"/>	CALIBRATION BOARD NOT FITTED.  CHECK: (1) Calibration board inserted correctly.
D	<input type="checkbox"/>	<input type="checkbox"/>	<input type="checkbox"/>	<input checked="" type="checkbox"/>	<input checked="" type="checkbox"/>	<input type="checkbox"/>	<input checked="" type="checkbox"/>	<input checked="" type="checkbox"/>	PRESET BOARD NOT FITTED.  CHECK: (1) Preset board inserted correctly.
E	<input checked="" type="checkbox"/>	<input type="checkbox"/>	<input type="checkbox"/>	<input checked="" type="checkbox"/>	<input checked="" type="checkbox"/>	<input type="checkbox"/>	<input checked="" type="checkbox"/>	<input checked="" type="checkbox"/>	DRIVE INCORRECTLY INDICATES SHAFT ROTATING.  CHECK: (1) Speed feedback signal (diagnostic 16). (2) Voltage appearing on terminal B2 with respect to terminal B1. (3) Wiring to terminals B2 and B1. (4) Preset board potentiometer P10.

DRIVE CONDITION INDICATORS - STATUS RECOGNITION

CONDITION REFERENCE								START CONDITION	
1 PHASE (AUX) ON/OFF								 LED ON  LED OFF  EITHER	
45-65 HZ ENABLE/INHIBIT									
3-PHASE (MAINS) ON/OFF									
NORMAL/TRIGGER FAULT									
NORMAL/OVERCURRENT FAULT									
RUN/INHIBIT									
ROTATING/STANDSTILL									
NORMAL/ALARM									
1	2	3	4	5	6	7	8	CONDITIONS/CHECKS	
A	●	○	○	●	●	○	○	●	NORMAL STOP CONDITION.
F	●	●	●	●	●	●	⊗	●	NORMAL RUN CONDITION.
G	●	○	○	●	●	○	○	●	DRIVE REMAINS IN STOP CONDITION. STATUS LEDS DO NOT CHANGE WHEN START BUTTON PRESSED. CHECK: (1) Drive is receiving Start Instruction (Diagnostic 9) (2) Continuity of stop line terminals C4 to C6. (3) Continuity of start line terminals C6 to C7.
H	●	○	○	●	●	○	○	○	ALARM CONDITION - START INSTRUCTION PRESENT BUT DRIVE NOT RECEIVING 3-PHASE. CHECK*: (1) Main contactor is pulled in. (2) Contactor coil connections (terminals D11 and D12). (3) Coil voltage is correct. (4) Coil resistance ie. not open circuit. (5) All three phases present on drive input terminals L1, L2 and L3. WARNING! High voltages appear on these terminals. (6) Fuses F1, F2, F3 and F4, F5, F6. WARNING! Isolate Drive from supply before Checking.
I	●	●	○	●	●	○	○	○	ALARM CONDITION - SPECIAL CASE OF ABOVE ONE PHASE ONLY MISSING. CHECK*: Items (5) and (6) in H above.
J	●	●	●	●	●	●	●	●	NORMAL RUN CONDITION - SHAFT ROTATING.
K	●	●	●	●	●	○	○	●	DRIVE INHIBITED BY 'ENABLE' SIGNAL AT C5. CHECK: (1) Drive enable (diagnostic 5). (2) Continuity between terminal C5 and start supply C4 OR C5 and +24V (NOMINAL) supply C11, as appropriate.
L	●	●	●	●	●	●	○	●	NORMAL RUN CONDITION - SHAFT STATIONARY IF INCREASING SETPOINT HAS NO EFFECT THEN: FOR SPEED CONTROL MODE CHECK: (1) Total Setpoint (diagnostic 15) is responding to the setpoint input. (2) That the Total Setpoint is positive in 546 and 548 units. (3) Main current limit (diagnostic 24) is not at zero. (4) Auxiliary current limits (diagnostics 22 and 23) are not at zero. (5) That the current demand is <u>not</u> isolated (diagnostic 19). (6) Motor armature connections (with supplies isolated). (7) Tacho connections correct (diagnostics 15 and 16). (8) Motor not stalled. Diagnostic 26 indicates armature current.  FOR TORQUE (CURRENT) CONTROL <u>ONLY</u> CHECK: Items 2, 3, 5, 7 and (8) Auxiliary current input (diagnostic 20) is not at zero. (9) Auxiliary current input is selected (diagnostic 21).

DRIVE CONDITION INDICATORS - STATUS RECOGNITION

CONDITION REFERENCE								START CONDITION	
1 PHASE (AUX) ON/OFF								 LED ON  LED OFF  EITHER	
45-65 HZ ENABLE/INHIBIT									
3-PHASE (MAINS) ON/OFF									
NORMAL/TRIGGER FAULT									
NORMAL/OVERCURRENT FAULT									
RUN/INHIBIT									
ROTATING/STANDSTILL									
NORMAL/ALARM									
1	2	3	4	5	6	7	8	CONDITIONS/CHECKS	
F	●	●	●	●	●	●	⊗	●	NORMAL RUN CONDITION.
M	●	●	●	●	●	○	○	○	DRIVE INHIBITED BY AUXILIARY ENABLE, OVERTEMPERATURE ALARM, FIELD FAILURE ALARM OR INTERMITTENT SUPPLY LOSS. CHECK*: (1) Auxiliary enable (Diagnostic 8). (2) Thermistor/Microtherm (Diagnostic 6). (3) Field Fail (Diagnostic 7). (4) Field voltage on terminals D5 and D8. (5) Field circuit continuity (isolate supplies before checking). (6) Fuses F7 and F8 (isolate supplies before checking). (7) Observe LEDs 2 and 3 for intermittent, momentary loss of supply.  WHERE AC SUPPLY TO THE FIELD RECTIFIER IS EXTERNAL (FIELD OPTIONS 4, 5 AND 6). CHECK: (8) AC Voltage on terminal D4 and D1.  FOR FORCE VENTILATED CONTROLLERS ONLY. CHECK: (9) Rotation of fans as stack thermal trip is in series with field fail.
N	●	●	●	○	●	○	○	○	ALARM CONDITION - TRIGGER FAULT, IF SETTING UP DRIVE FOR FIRST TIME OR SETTINGS HAVE BEEN ADJUSTED INDICATES EXTREME INSTABILITY. CAREFULLY FOLLOW DRIVE SETTING UP PROCEDURE.** OTHERWISE, CHECK: (1) Diagnostic 26. Observe armature waveform on oscilloscope. If one or more Thyristors is not being turned on drive will trip.**
P	●	○	○	●	○	○	○	○	ALARM CONDITION - OVERCURRENT FAULT, IF SETTING UP DRIVE FOR FIRST TIME OR SETTINGS HAVE BEEN ADJUSTED, INDICATES EXTREME INSTABILITY. CAREFULLY FOLLOW DRIVE SETTING UP PROCEDURE.** OTHERWISE, CHECK: All external connections, in particular, motor supply and supply connections**

\* If terminal C3 is connected to C10 these alarm conditions will latch, they may be reset by operating the Stop/Start controls.

\*\* To reset the drive, fault reset must be operated and the drive restarted.

DIAGNOSTIC CHART 3

DIAGNOSTIC TEST UNIT - VOLTAGE MEASUREMENTS

TEST NO.	DIAGNOSTIC TEST POINT DESCRIPTION	CONDITION	VOLTAGE
1	Internal +15V Supply	Aux. Power ON	+15V $\pm$ 0.25V Max. 100Hz ripple=25mV peak to peak
2	External +10V Supply  Note: These supplies are buffered from internal reference supplies and have a maximum output current capability of 25mA.	Aux. Power ON	+10V $\pm$ 0.1V Max. 100Hz ripple=5mV peak to peak
3	External -10V Supply	Aux. Power ON	-10V $\pm$ 0.1V Max. 100Hz ripple=5mV peak to peak
4	Internal -15V Supply	Aux. Power ON	-15V $\pm$ 0.25V Max. 100Hz ripple=25mV peak to peak
5	<u>Drive Enable</u> Enable = +24V(Nominal) on terminal C5 Inhibit = open circuit to terminal C5	Enable Inhibit	+7V $\pm$ 4V $\leq$ -5V
6	Motor Thermistor/Microtherm	Motor temperature correct Motor over temperature	+0.5V $\pm$ 0.5V -14V $\pm$ 1.25V
7	<u>Field Fail</u> Notes: 1. This signal is interlocked with the internal temperature sensor (force ventilated units only) and the internal ACCT connectors. 2. Internally supplied fields will normally excite when the 3-phase power is connected to the drive i.e. only in the run condition, with the main contactor energised. 3. Excitation of externally controlled fields will depend on the application. 4. Permanent magnet motor, field weakening and remote field supply applications will employ field failure override. This will provide a constant 'field normal' signal.	Field AND Interlocks Normal Field OR Interlocks Fail	+0.5V $\pm$ 0.5V -14V $\pm$ 1.25V
8	<u>Auxiliary Enable</u> Enable = +24V(Nominal) on terminal C3 Inhibit = Open circuit to terminal C3	Enable Inhibit	+0.5V $\pm$ 0.5V -14V $\pm$ 1.25V
9	<u>Start Instruction</u>	Run Stop	+0.5V $\pm$ 0.5V -14V $\pm$ 1.25V

DIAGNOSTIC TEST UNIT - VOLTAGE MEASUREMENTS

TEST NO.	DIAGNOSTIC TEST POINT DESCRIPTION	CONDITION	VOLTAGE
10	<u>Setpoint Ramp Reset</u> Enable = Open circuit to terminal A3 Reset to Zero = Connect terminal A3 to A1 (0V)  Note: Setpoint ramp output is also reset to zero when run/inhibit LED 6 is out.	Ramp Enable AND Run Ramp Reset OR Stop	-14V $\pm$ 1.25V 0V $\pm$ 0.1V
11	<u>Setpoint Ramp Input</u> Connects directly to terminal A4 and measures the incoming speed demand signal. If terminal A4 is not used the voltage measured should be zero.	<u>Variable Input:</u> 100% forward speed demand. Zero speed or terminal A4 not used 100% reverse speed demand*.	+10V 0V -10V
12	<u>Input No. 1</u> Connects directly to terminal A6 and measures the incoming speed demand signal. If terminal A6 is not used the voltage measured should be zero.	<u>Variable Input:</u> 100% forward speed demand. Zero speed or terminal A6 not used 100% reverse speed demand*.	+10V 0V -10V
13	<u>Input No. 2</u> Connects directly to terminal A7 and measures the incoming speed demand signal. If terminal A7 is not used the voltage measured should be zero.	<u>Variable Input:</u> 100% forward speed demand. Zero speed or terminal A7 not used 100% reverse speed demand*.	+10V 0V -10V
14	<u>Input No. 3</u> Connects directly to terminal A9 and measures the incoming inverted speed demand signal. If terminal A9 is not used the voltage measured should be zero.  Note: That input No. 3 is of the opposite sense to all other speed inputs.	<u>Variable Input:</u> 100% forward speed demand. Zero speed or terminal A9 not used 100% reverse speed demand*.	-10V 0V +10V
15	<u>Total Setpoint</u> This is the sum of all the speed demand signals, i.e. Input No. 1, plus Input No. 2, plus Setpoint Ramp Input (if S3 is closed), minus Input No. 3. It is clamped to a maximum output of $\pm$ 11V.	<u>Variable Signal:</u> 100% forward speed demand. Zero speed. 100% reverse speed demand*.	+10V 0V -10V
16	<u>Speed Feedback</u> This is the scaled and buffered tachogenerator speed feedback signal (under steady state conditions it should be of opposite polarity but equal in magnitude to the Total Setpoint measured on diagnostic 15).	<u>Variable Signal:</u> 100% forward speed. Zero speed. 100% reverse speed*.	-10V 0V +10V
17	<u>Speed Error</u> This is of opposite polarity to the difference between the Total Setpoint and speed feedback voltages. The magnitude of this signal is dependant on the setting of the Speed Proportional Gain (P5) and includes any Zero Speed offset value.	Run - Variable Signal - Normal Steady State value -  Stop - Total Setpoint = 0V Total Setpoint $\neq$ 0V	up to $\pm$ 10V 0V Approx  0V $\pm$ 0.2V up to $\pm$ 10V

\* 545 and 547 drives only.



DIAGNOSTIC TEST UNIT - VOLTAGE MEASUREMENTS

TEST NO.	DIAGNOSTIC TEST POINT DESCRIPTION	CONDITION	VOLTAGE
18	<p><u>Current Demand</u>  This signal is held to zero except in the run condition when it is released by Main System Enable.</p> <p>Main System Enable depends on the "Run/Inhibit" signal (LED 6) and on the Standstill Logic (if switch S2 is closed).</p>	<p>Run - Variable Signal - 545 &amp; 547  - 546 &amp; 548</p> <p>Stop - (or Standstill)</p>	<p>+10V  0 to +10V  0V <math>\pm</math>0.1V</p>
19	<p><u>Current Demand Isolate</u>  Connects directly to terminal B3.</p> <p>NOTE: 1. For speed control operation leave terminal B3 open circuit.  2. For current control operation connect terminal B3 to B1 (0 Volts).</p>	<p>Speed control.  Current control.</p>	<p>-14V <math>\pm</math>1.25  0V <math>\pm</math>0.1V</p>
20	<p><u>Auxiliary Current Input</u>  Connects directly to terminal B5.</p> <p>Only operational if selected (See Diagnostic 21).</p>	<p><u>Variable Input</u> (if used):  Positive Bridge current = 200% FLC*  Zero Current.  Negative Bridge current = 200% FLC* (545 &amp; 547 only)  * FLC = Full Load Current.</p>	<p>+10V  0V  -10V</p>
21	<p><u>Select Auxiliary Input</u>  Connects directly to terminal B6.</p> <p>NOTE: 1. To select input connect terminal B6 to 0 Volts (terminal B1).  2. To disconnect input leave terminal B6 open circuit.</p>	<p>Select Input.  Disconnect Input.</p>	<p>0V <math>\pm</math>0.1V  -14V <math>\pm</math>1.25</p>
22	<p><u>Auxiliary Current Limit (Positive)</u>  Connects directly to terminal B7.</p> <p>NOTE: 1. This positive current limit only operates up to the limit set by the Main Current Limit preset (P7) at Diagnostic 24.  2. If no special limit is required leave terminal B7 open circuit.</p>	<p>Terminal B7 open circuit.  <u>Variable Input</u>:  Positive current limit = 200% FLC*  Positive current limit zero.  * FLC = Full Load Current.</p>	<p>+12V <math>\pm</math>2V  +10V  0V</p>
23	<p><u>Auxiliary Current Limit (Negative)</u>  Connects directly to terminal B10.</p> <p>NOTE: 1. This negative current limit only operates up to the limit set by the Main Current Limit preset (P7) at Diagnostic 24.  2. If no special limit is required leave terminal B10 open circuit.  3. IN ALL 546 AND 548 APPLICATIONS TERMINAL B10 MUST BE OPEN CIRCUIT.</p>	<p>Terminal B10 open Circuit (see note 3).  <u>Variable Input</u>:  Negative current limit = 200% FLC*  Negative current limit zero.  * FLC = Full Load Current.</p>	<p>-12V <math>\pm</math>2V  -10V  0V</p>

DIAGNOSTIC TEST UNIT - VOLTAGE MEASUREMENTS

TEST NO.	DIAGNOSTIC TEST POINT DESCRIPTION	CONDITION	VOLTAGE
24	<p><u>Main Current Limit</u>  Overrides Auxiliary Current Limits (see Diagnostic 22 and 23).</p> <p>Scaling: 0 to +10V equivalent to 0 to 200% Full Load Current (FLC).</p> <p>Characteristics:  (i) When set between 0 and 5.5V (0 to 110% FLC*) the set current is available continuously.  (ii) When set between 5.5 and 10V (110 to 200% FLC*) the current is controlled by an overload inverse time characteristic. The absolute limit is fixed at the set value and the current is allowed to exceed 110% FLC* for a short time before it is automatically cut back to 110%. The time allowed in this over current region depends on the magnitude of the overload e.g. 150% load is permitted for approximately 30 secs before cut back starts. 200% load is permitted for approximately 10 seconds before cut back starts.</p>	<p>Variable Voltage depending upon the input to terminal B8 (normally +10V) and the setting of the Main Current Limit Potentiometer P7.</p>	0 to +10V
25	<p><u>Total Current Demand (Inverted)</u>  This is the net current demand signal (inverted).  It is limited by the current limit settings and the overload inverse time characteristic.  It is held to zero except in the run condition when it is released by the Main System Enable.  The Main System Enable depends on the "Run/Inhibit" signal (LED 6) and on the Standstill logic (if switch S2 is closed).</p>	<p><u>Variable demand in run condition:</u>  Positive Bridge Current = 200% FLC*  Zero Current.  Negative Bridge Current = 200% FLC* (545 &amp; 547 only)  In stop condition.  * FLC = Full Load Current.</p>	<p>-10V  0V  +10V  0V</p>
26	<p><u>Current Feedback</u>  Measured armature current signal.</p> <p>This is an isolated signal which is directly proportional to the Armature Current.  Under steady state conditions it should be of opposite polarity but equal in magnitude to the Total Current Demand signal at Diagnostic 25.</p>	<p><u>Variable signal in run condition:</u>  Positive Bridge Current = 200% FLC*  Zero current.  Negative Bridge Current = 200% FLC* (545 &amp; 547 only)  * FLC = Full Load Current.</p>	<p>+2.2V  0V  -2.2V</p>
27	<p><u>Phase Angle</u>  This signal is held to zero except in the run condition when it is released by Main System Enable.</p> <p>Main System Enable depends on the "Run/Inhibit" signal (LED 6) and on the Standstill Logic (if switch S2 is closed).  Signal value is limited if no tachogenerator feedback signal is present in order to help prevent over speeding of the motor.</p>	<p><u>Variable Signal in run condition:</u>  Positive phase angle. (545 &amp; 547 only)  Zero phase angle.  Negative phase angle.  Tacho loss (i.e. No tacho signal).</p>	<p>up to +10V  0V  up to -10V  Limited to <math>\pm(4.7V \pm 0.2)</math></p>

**SPARE PART IDENTIFICATION LIST**

Except where otherwise stated, parts are suitable for all convertors in the range 545, 546, 547 and 548.

**PRINTED CIRCUIT BOARDS**

**PART NUMBER**

Three Phase Control Board - 545 & 547. . . . .	AH047423U002
- 546 & 548. . . . .	AH047423U003
Three Phase Trigger Board - 545 & 547. . . . .	AH047644U002
- 546 & 548. . . . .	AH047644U003
Power Supply Board . . . . .	AH047833U002
Calibration Board. . . . .	AH046789U002
Preset Potentiometer Board . . . . .	AH046821U002

Field Suppression Board. . . . .) These P.C.B.'s are Product Code dependent -  
Three Phase Suppression Board (545 & 546 only) . . .) select from the chart below:

3-PHASE SUPPLY VOLTAGE OPTION (PRODUCT CODE BLOCK 3)	3-PHASE SUPPRESSION BOARD PART NUMBER	FIELD SUPPRESSION BOARD PART NUMBER
0 - 110v 1 - 115v 2	AH054555U002	LA048620
3 - 220v 4 - 240v		
5 - 380v 6 - 415v	AH054555U003	LA048621
7 - 440v 8 - 460v 9 - 480v	AH054555U004	LA048622

**FUSES**

**PART NUMBER**

Auxiliary Supply Fuse (FS9), 3A 250v, (1 off used) . . . . .	CH020033
Coding Supply Fuses (FS4, 5 & 6)* (3 off used) - 545 & 546 - 8A 440v, Ferraz type G84393 . .	CH200083
- 547 & 548 - 20A 600V, Ferraz type N88654. . . . .	CH220024
Field Supply Fuses (FS7 & 8)* (2 off used) - 8A 440v, Ferraz type G84393 . . . . .	CH200083
Main Supply Fuses (FS1, 2 & 3)* (3 off used) . . . . .	These Fuses are Product code dependent - select from the chart below:

CONVERTOR TYPE (PRODUCT CODE BLOCK 1)	OUTPUT CURRENT RATING (PRODUCT CODE BLOCK 2)	FUSE PART NUMBER
545 & 546	Up to 35A (0001 - 0350)	CH110353
	35.1A to 70A (0351 - 0700)	CH120753
	70.1A to 110A (0701 - 1100)	CH120114
	110.1A to 180A (1101 - 1800)	CH120154
547 & 548	Up to 300A (0001 - 3000)	CH133253
	300.1A to 360A (3001 - 3600)	CH130354

\* **IMPORTANT NOTE:** These are High Speed Semiconductor Protection Fuses, use of any other type invalidates Warranty and may result in serious damage to the controller.

**SEMICONDUCTORS**

Field Bridge . . . . .) )  
Field Bridge VDR (1 off used). . . . .) ) These items are Product Code dependent -  
Line VDR (3 off used). . . . .) ) select from the chart below:

3-PHASE SUPPLY VOLTAGE OPTION (PRODUCT CODE BLOCK 3)	FIELD BRIDGE PART NUMBER	FIELD VDR. PART NUMBER	LINE VDR. PART NUMBER	
			545 & 546	547 & 548
0 - 110v	CWO47521	CK047723	CK047723	CK049159
1 - 115v				
2				
3 - 220v				
4 - 240v	CWO47076	CK047692	CK047692	CK049160
5 - 380v				
6 - 415v	CWO47379	CK047693	CK047693	CK049161
7 - 440v				
8 - 460v				
9 - 480v				

Thyristors. . . . .These are Product Code dependent and should be selected from the chart below:

3-PHASE SUPPLY VOLTAGE OPTION (PRODUCT CODE BLOCK 3)	OUTPUT CURRENT RATING (PRODUCT CODE BLOCK 2)					
	545 & 546				547 & 548	
	UP TO 35A (0001-0350)	35.1-70A (0351-0700)	70.1-110A (0701-1100) *	110.1-180A (1101-1800) *	UP TO 300A (0001-3000) *	300.1-360A (3001-3600) *
0 = 110v	CF047889	CF047891	CF047891	CF047892	CF057444U012	CF057444U012
1 = 115v						
2						
3 = 220v						
4 = 240v						
5 = 380v						
6 = 415v	CF047894	CF047896	CF047896	CF047897	CF057444U016	CF057444U016
7 = 440v						
8 = 460v						
9 = 480v						

\* Note that these are Force Ventilated units.

MISCELLANEOUS

PART NUMBER

Mains Transformer* . . . . .	C0047686
Field Current Transformer* . . . . .	C0043469
Pulse Transformer* . . . . .	C0047522
Main Current Transformer Assembly (2 off C.T. plus leads) - 545 - LA048716	546 - LA048717
Main Current Transformer Only - . . . . . 545 - C0047654	546 - C0047653
- . . . . . 547 - C0049123	548 - C0049122
Connector, Female, 4 Way (Complete set of 12). . . . .	LA047525
Connector, Male, 4 Way, P.C.B. Mounting* . . . . .	CI047088
Front Cover - 545 & 546. . . . .	LA047643
- 547 & 548 - Upper. . . . .	LA047643
- Lower. . . . .	LA049439
Legend Plate Assembly (Incl. W Buttons) - Diagnostic Version (Product Code Block 8 = 1). . .	LA048630
- Non-Diagnostic Version (Product Code Block 8 = 0). . .	LA048631
W Buttons. . . . .	FI044705
Fuse Panel Assembly (Less Fuses) - 545 & 546 only - Up to 35A. . . . .	LA048700
- Over 35A . . . . .	LA048701
Ribbon Cable Assembly 14 way . . . . .	CM047819
Ribbon Cable Assembly 24 way . . . . .	CM047938
Relay for Power Board . . . . .	DS047687
Field Loom (545/546) . . . . .	DN048718

Force Ventilated Units Only:

Over Temperature Switch. . . . . DC048855

Blower Fan . . . . .) These items are Product Code dependent -  
Blower Fan Capacitor (where applicable). . . . .) select from the chart below:

AUXILIARY SUPPLY VOLTAGE OPTION (PRODUCT CODE BLOCK 5)	OUTPUT CURRENT RATING (PRODUCT CODE BLOCK 2)		
	70.1-150A (0701-1500)	150.1-360A (1501-3600)	
	BLOWER FAN PART NUMBER	BLOWER FAN PART NUMBER	BLOWER FAN CAPACITOR PART NUMBER
0 - 110V	DL047934	DL049140	CY0 54234
1 - 115V			
3 - 220V	DL047933	DL049141	CY0 55383
4 - 240V			

RECOMMENDED MINIMUM SPARES HOLDING

NOTE: For Product Code dependant items ensure that the correct Part Number is used.

- 1 off Each type of Printed Circuit Board.
- 2 off Auxiliary Supply Fuse.
- 4 off Field Supply Fuses.\*\*
- 3 off Coding Supply Fuses.\*\*
- 6 off Main Supply Fuses.\*\*
- 4 off Thyristor Packs.
- 1 off Field Bridge.

\* P.C.B. Mounted Components.

\*\* These are High Speed Semiconductor Protection Fuses, use of any other type invalidates Warranty and may result in serious damage to the controller.

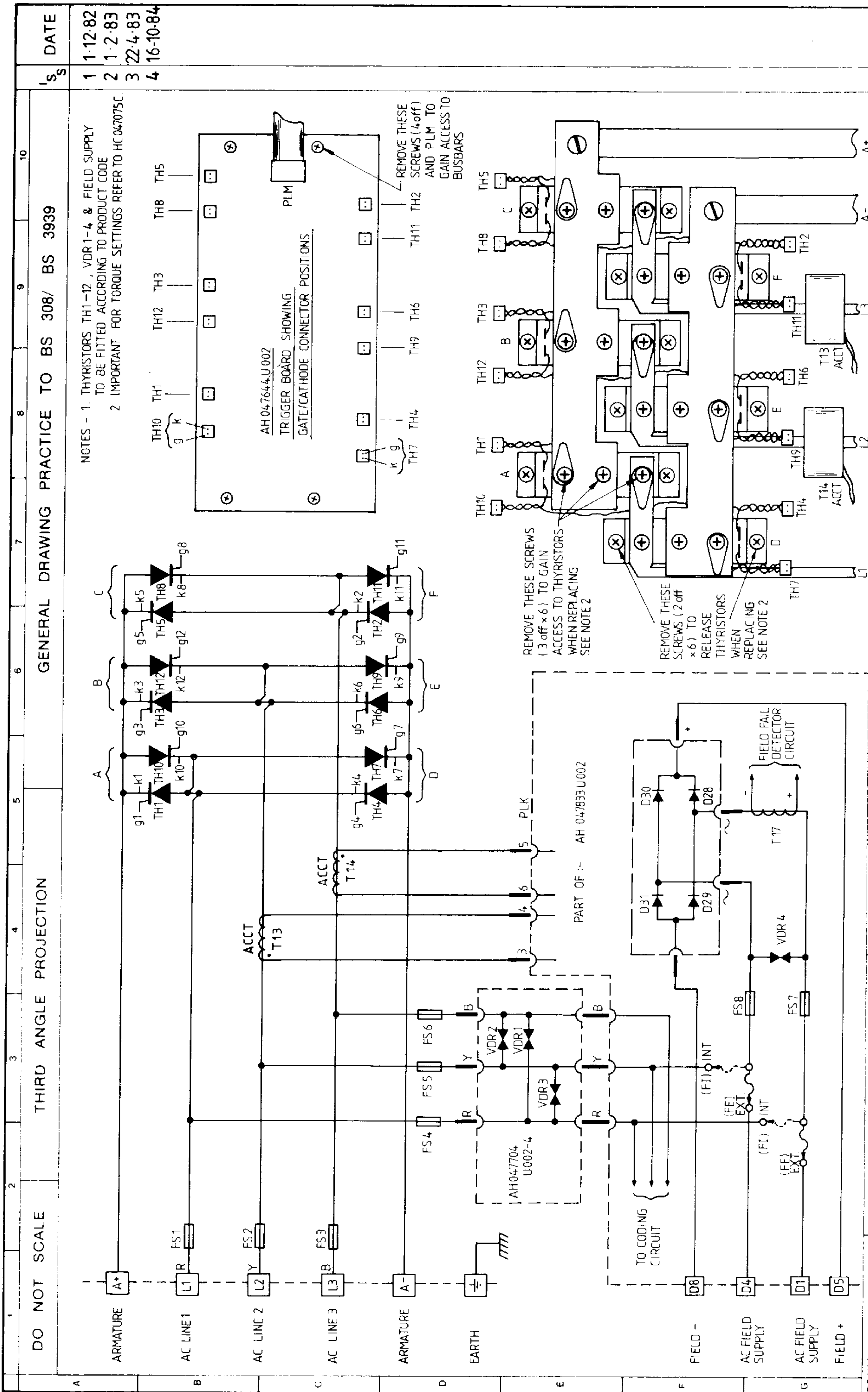

NOTES - 1. THYRISTORS TH1-12, VDR1-4 & FIELD SUPPLY TO BE FITTED ACCORDING TO PRODUCT CODE  
 2. IMPORTANT FOR TORQUE SETTINGS REFER TO HC 047075C.

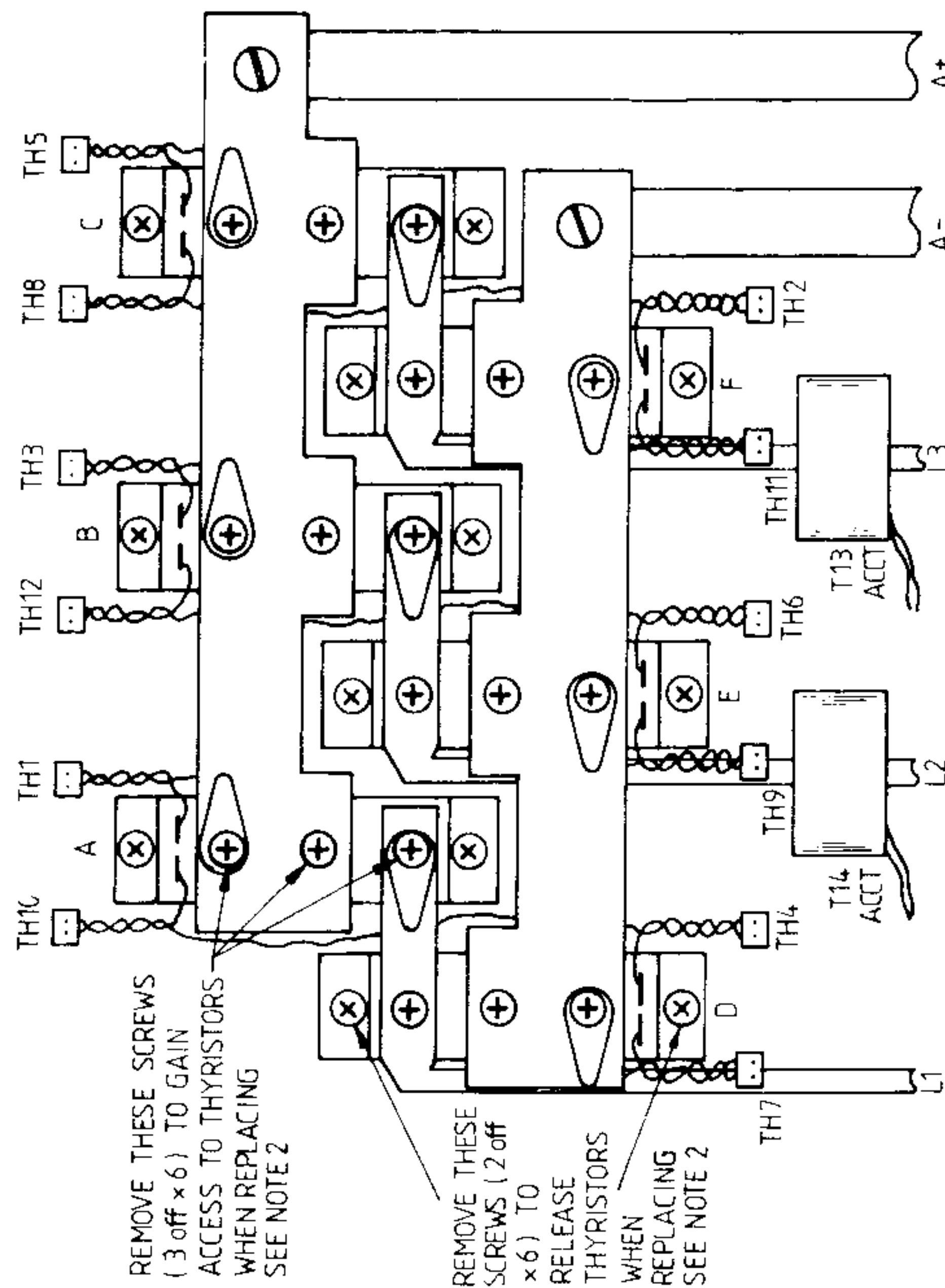
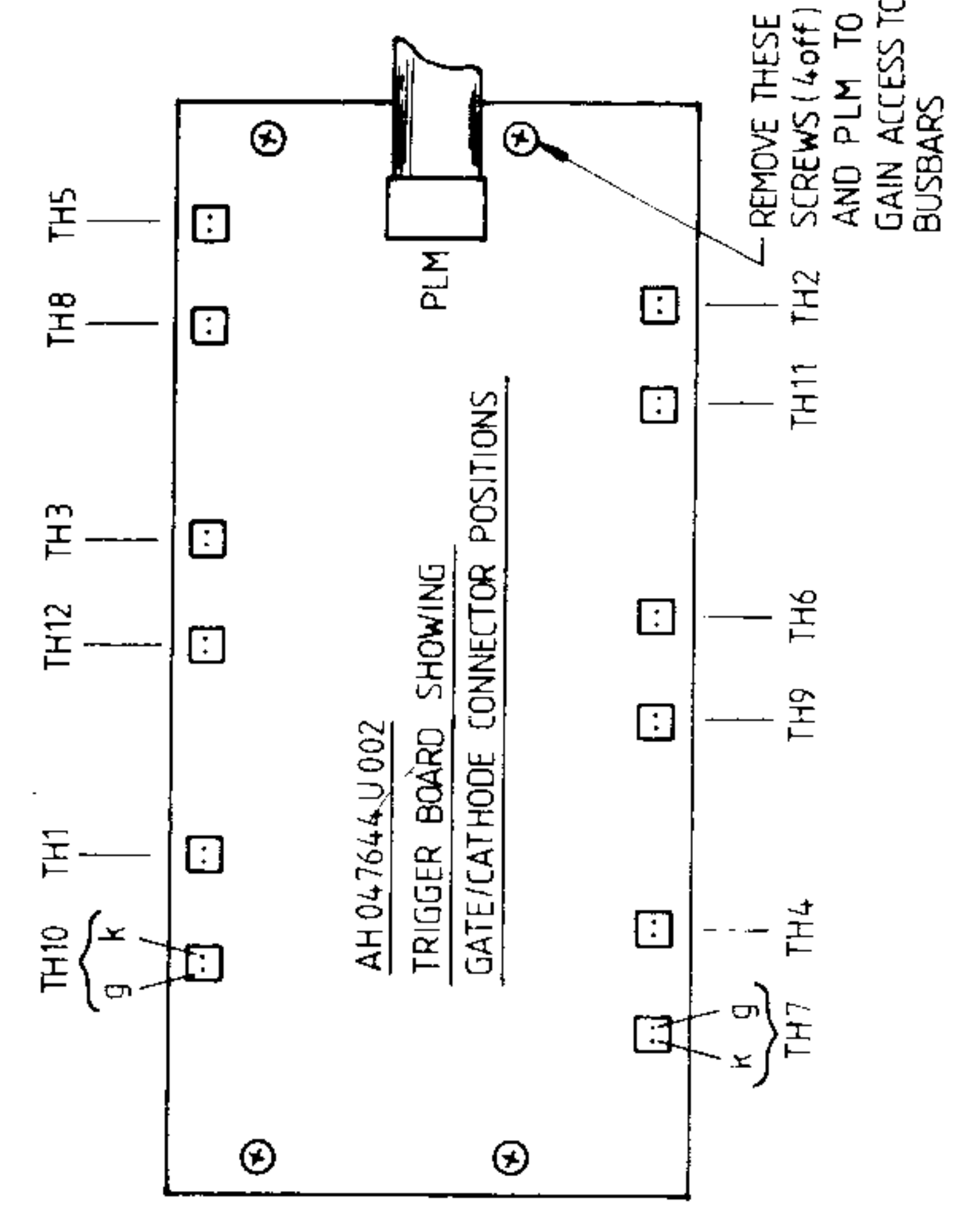

DO NOT SCALE		THIRD ANGLE PROJECTION		GENERAL DRAWING PRACTICE TO BS 308/ BS 3939						DATE 1 1-12-82 2 1-2-83 3 22-4-83 4 16-10-84	
DRAWN DJH		MATERIAL		ASSEMBLED ON 545		SCALE		TITLE 545 POWER CIRCUIT & CONFIGURATION			
CHECKED		FINISH		DIM'S IN M.M. APPLY OVER FINISH (EXCEPT FOR PAINT AND LAQUER)		SHACKLETON system drives		DRAWING NUMBER HJ 049416 D			
DESIGN APPROVAL		GENERAL TOLERANCE		X = ± 0.4 XX = ± 0.2 XXX = ± 0.1		Holes < 0.7 mm -0.02-0.01		SHT 1 OF 1 SHTS			
MANUFACTURE APPROVAL		K.T. 043008									

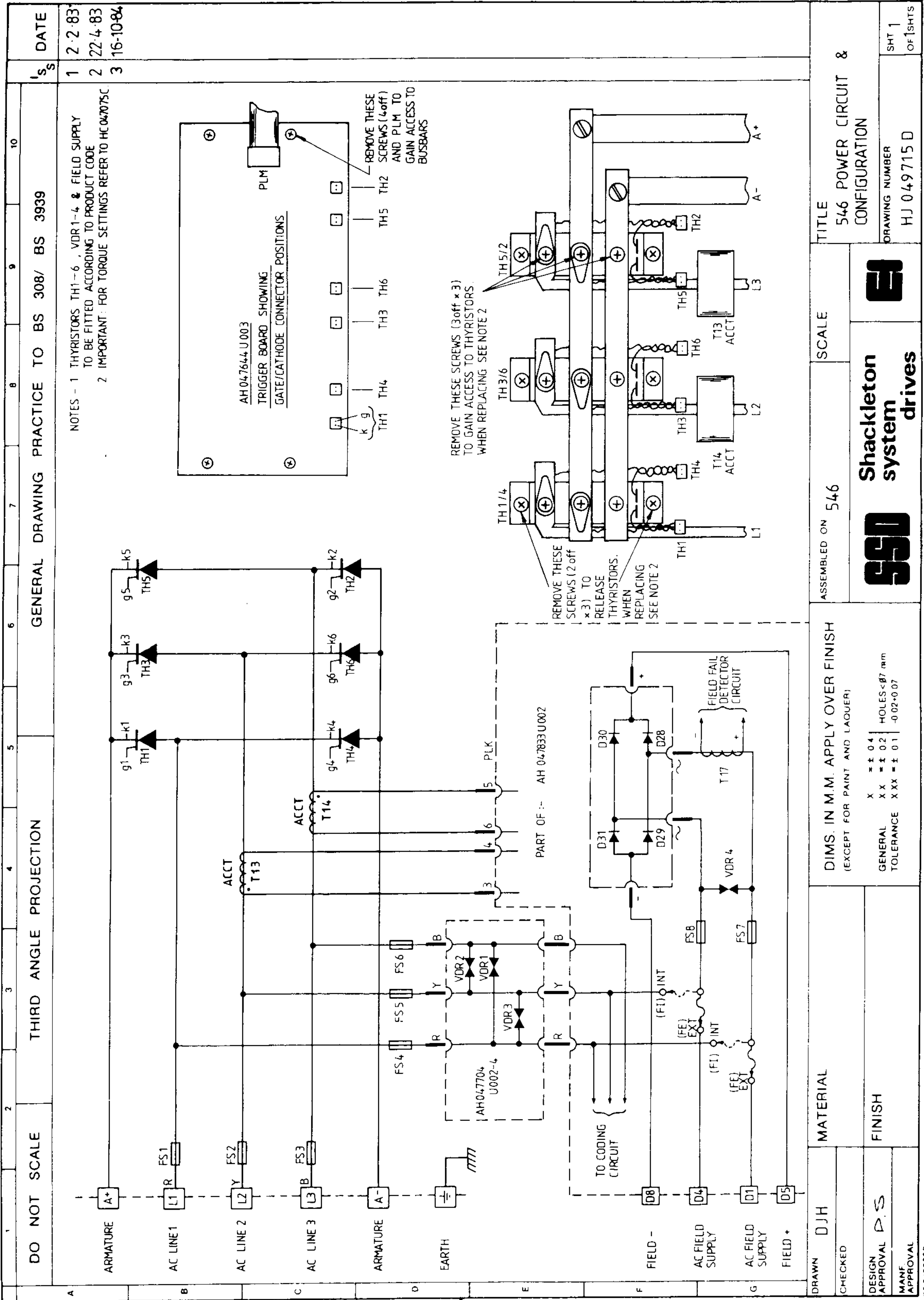

NOTES - 1 THYRISTORS TH1-6, VDR1-4 & FIELD SUPPLY TO BE FITTED ACCORDING TO PRODUCT CODE  
 2 IMPORTANT: FOR TORQUE SETTINGS REFER TO HC04075C

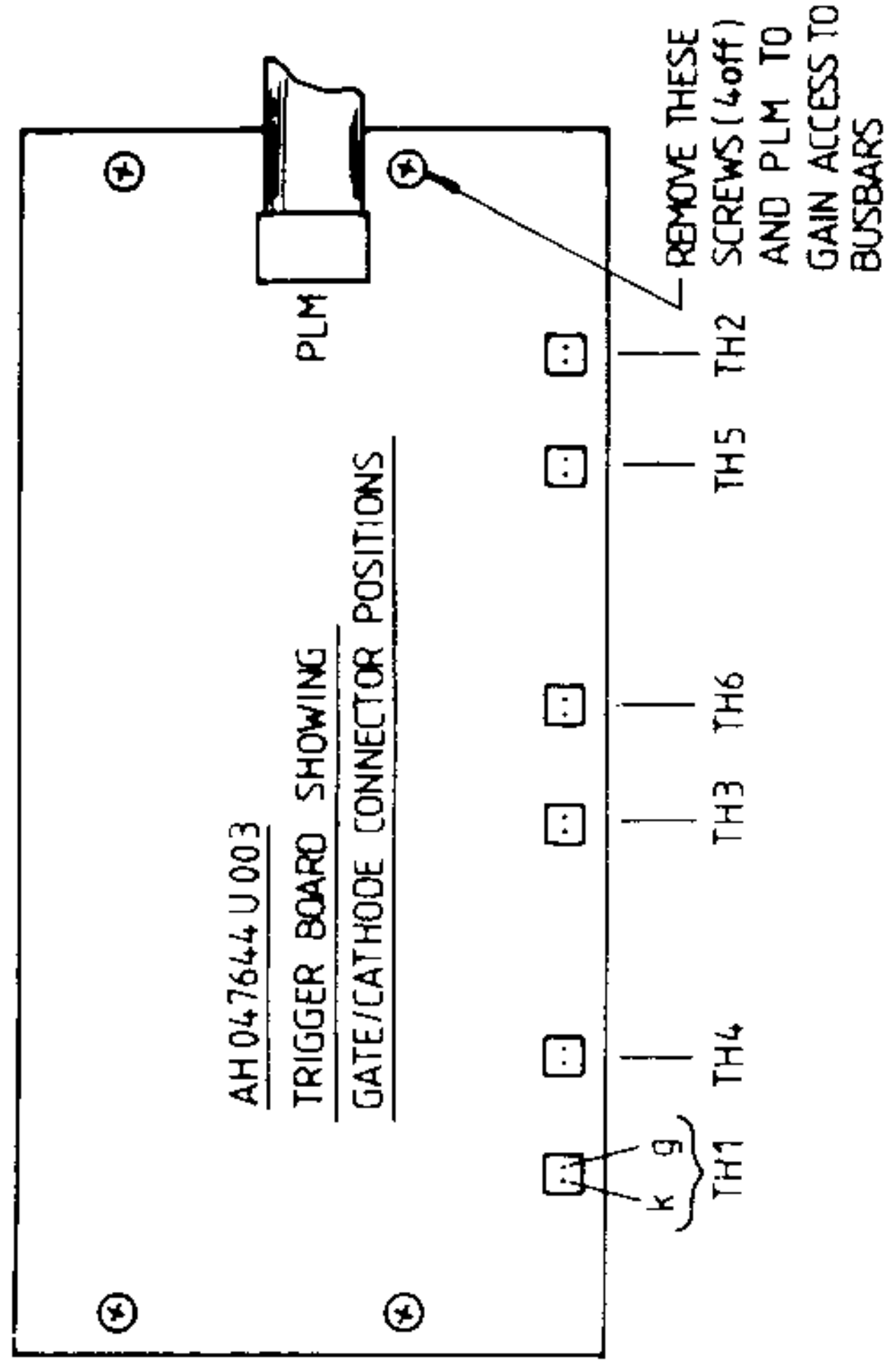

REMOVE THESE SCREWS (3 off x 3) TO GAIN ACCESS TO THYRISTORS WHEN REPLACING SEE NOTE 2

REMOVE THESE SCREWS (2 off x 3) TO RELEASE THYRISTORS WHEN REPLACING SEE NOTE 2

DO NOT SCALE		THIRD ANGLE PROJECTION		GENERAL DRAWING PRACTICE TO BS 308/ BS 3939		DATE	
1		2		3		1	
2		3		4		2	
3		4		5		3	
4		5		6		16-10-84	
5		6		7			
6		7		8			
7		8		9			
8		9		10			
ASSEMBLED ON		SCALE		TITLE		SHT 1 OF 1SHTS	
546		546		546 POWER CIRCUIT & CONFIGURATION		DRAWING NUMBER HJ 049715 D	
DIMS. IN M.M. APPLY OVER FINISH (EXCEPT FOR PAINT AND LAQUER)		Shackleton system drives		SSD			
GENERAL TOLERANCE		X ± 0.4		X X ± 0.2		HOLES < 87 mm	
TOLERANCE		X XX ± 0.1				-0.02+0.07	
DRAWN DJH		MATERIAL		FINISH			
CHECKED							
DESIGN APPROVAL P.S							
MANF APPROVAL							

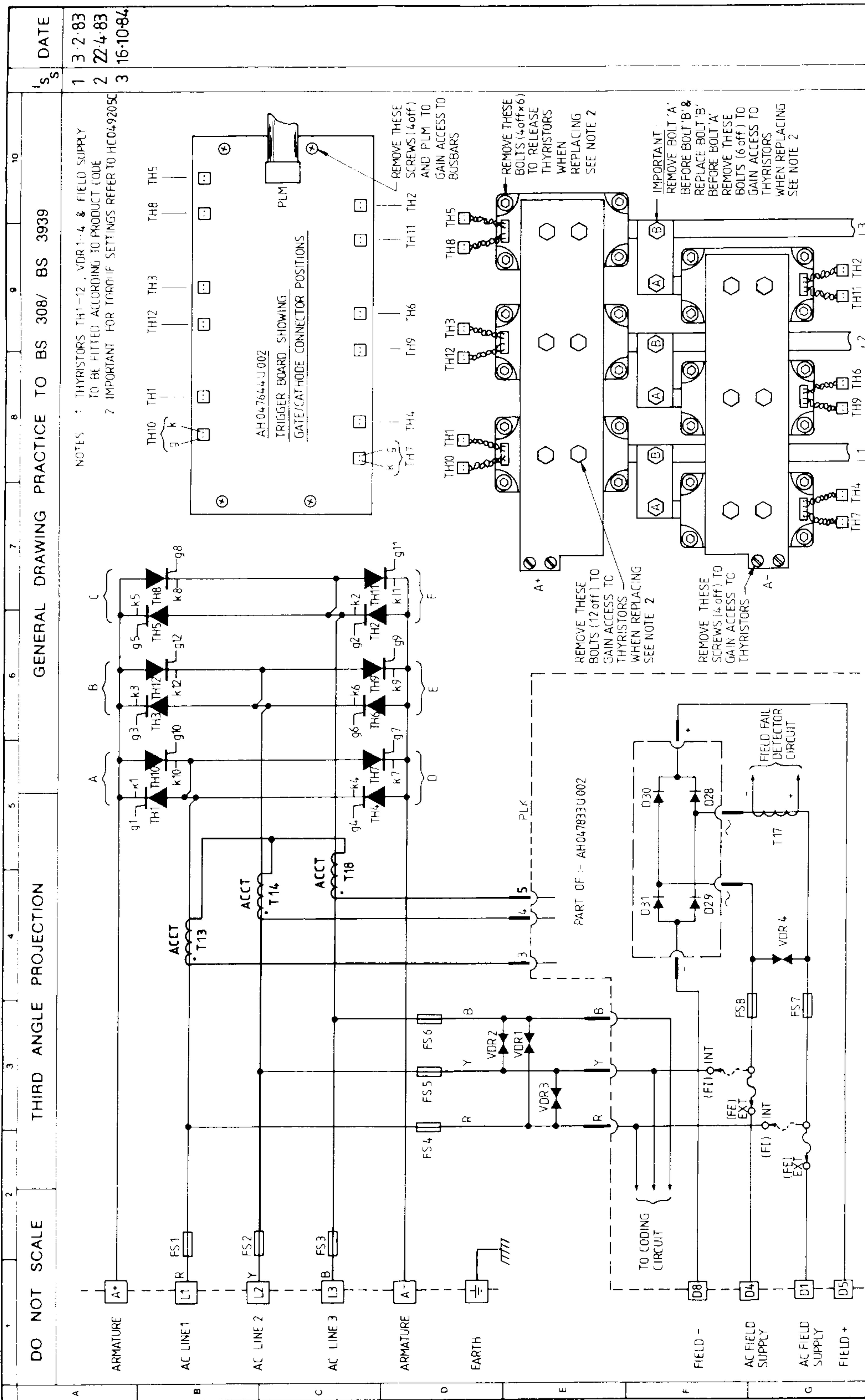

GENERAL DRAWING PRACTICE TO BS 308/ BS 3939

NOTES : 1 THYRISTORS TH1-12, VDR1-4, & FIELD SUPPLY TO BE FITTED ACCORDING TO PRODUCT CODE  
 2 IMPORTANT FOR TORQUE SETTINGS REFER TO HC049205C

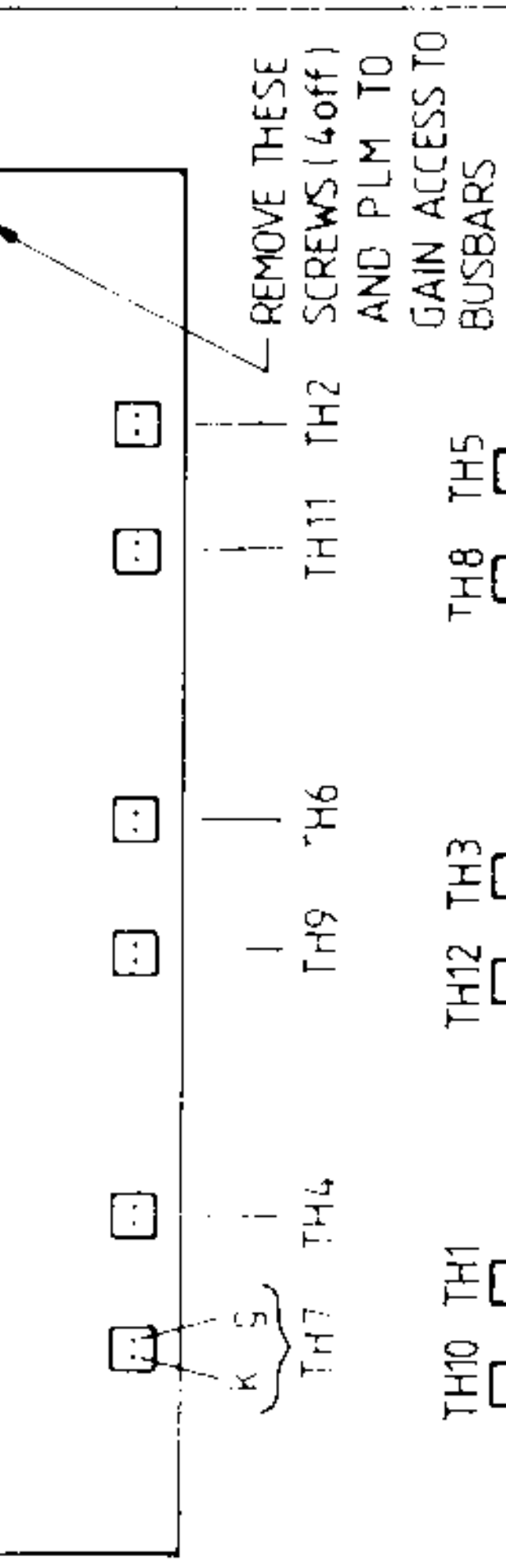
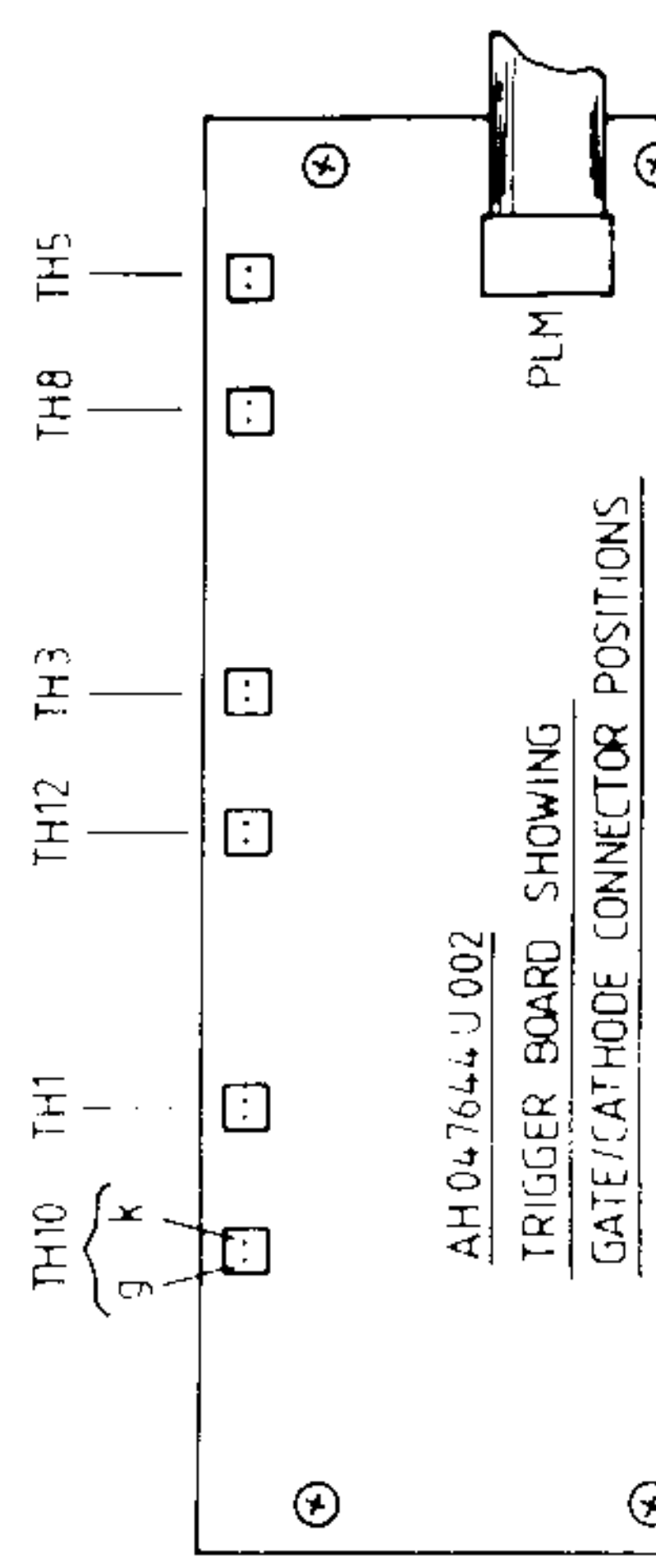

DO NOT SCALE

THIRD ANGLE PROJECTION

DATE

1 3.2.83  
 2 22.4.83  
 3 16.10.84

DRAWN DJH		MATERIAL		ASSEMBLED ON 547		SCALE		TITLE	
CHECKED								547 POWER CIRCUIT & CONFIGURATION	
DESIGN APPROVAL DS		FINISH						DRAWING NUMBER HJ 049718D	
MANF APPROVAL								SHT 1 OF 1 SHTS	



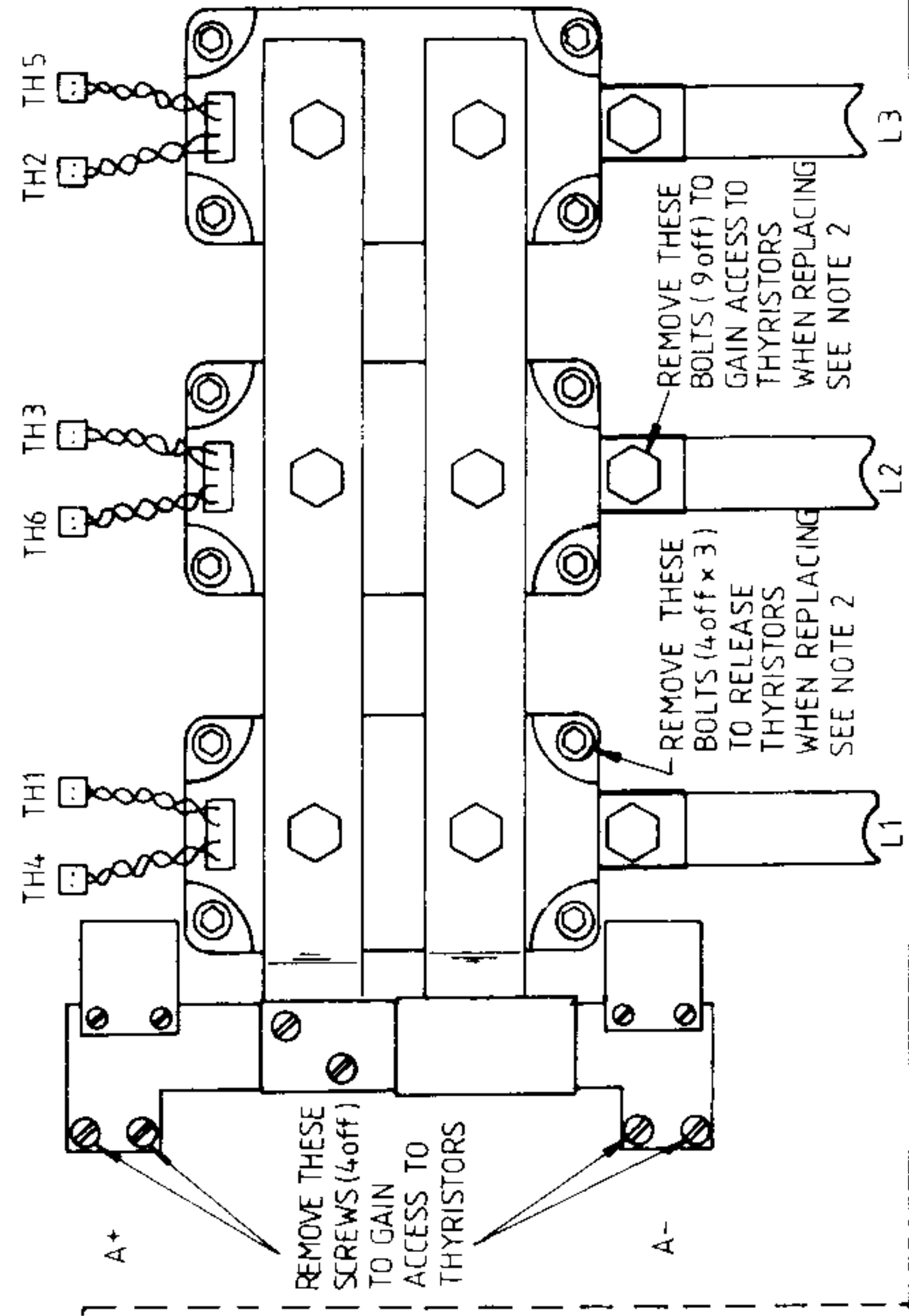
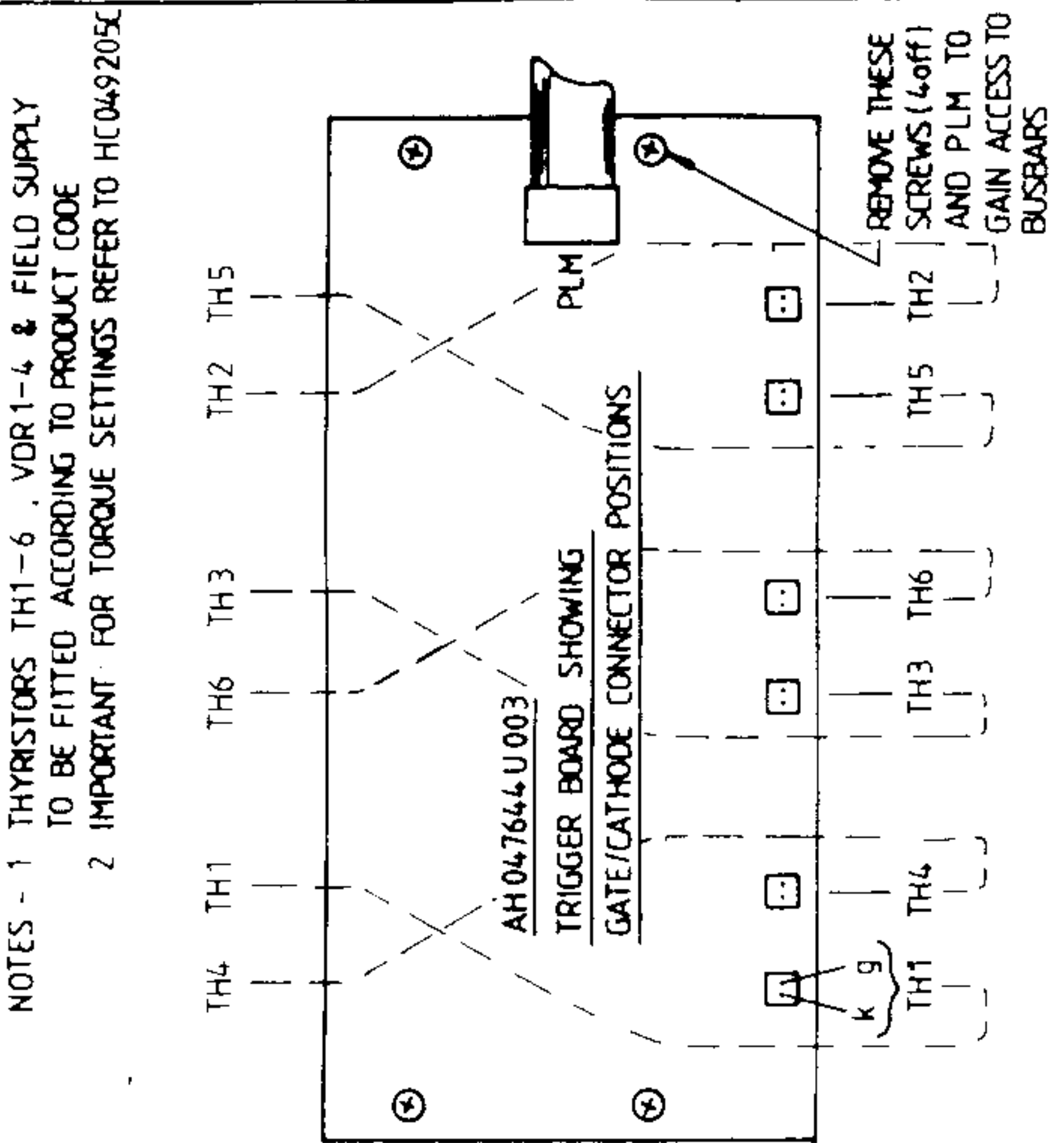
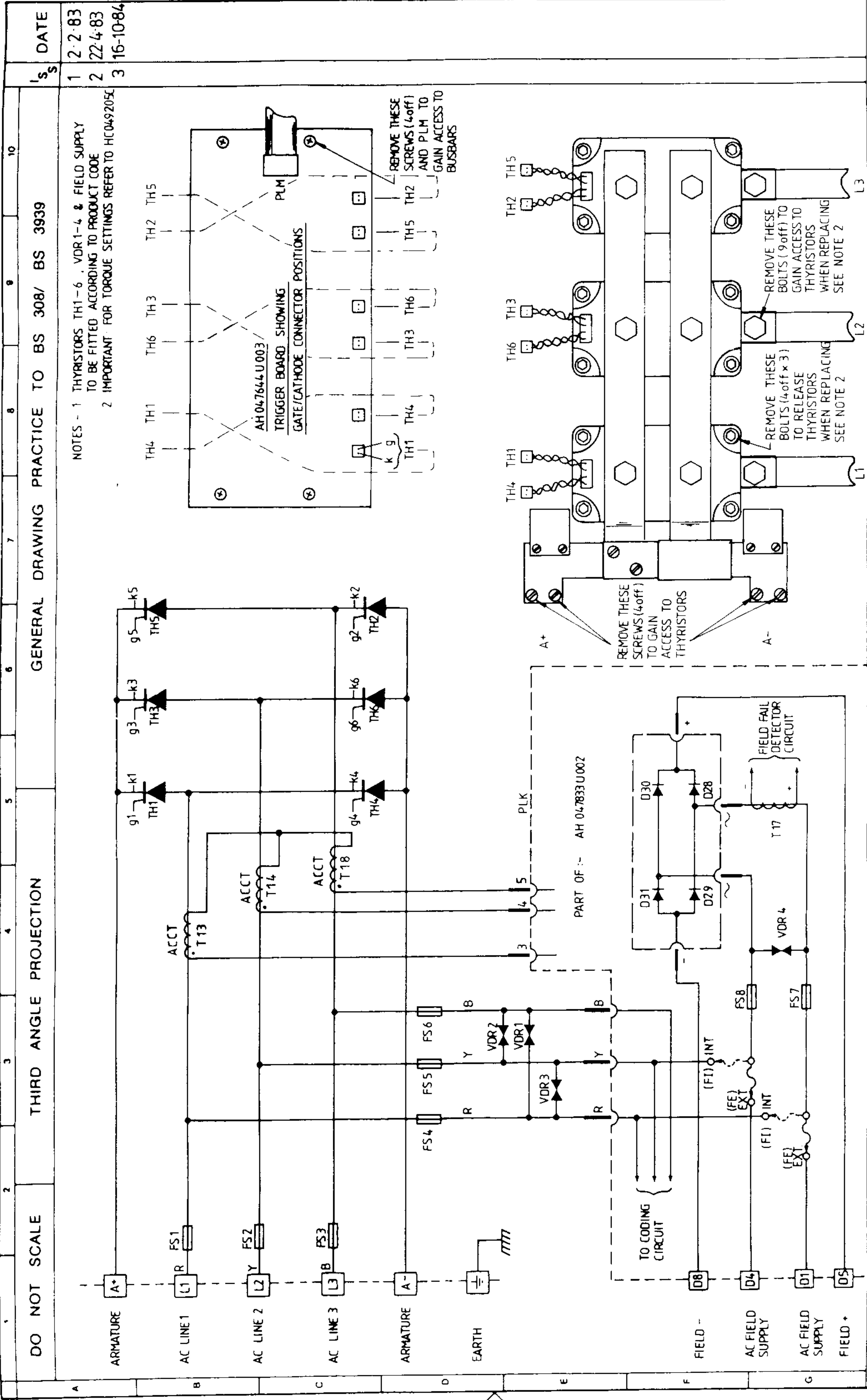

DO NOT SCALE  
 THIRD ANGLE PROJECTION  
 GENERAL DRAWING PRACTICE TO BS 308/ BS 3939

NOTES - 1 THYRISTORS TH1-6, VDR1-4 & FIELD SUPPLY TO BE FITTED ACCORDING TO PRODUCT CODE  
 2 IMPORTANT FOR TORQUE SETTINGS REFER TO HC049205E

DATE  
 1 2-2-83  
 2 22-4-83  
 3 16-10-84

DRAWN DJH		MATERIAL		ASSEMBLED ON 548		SCALE		TITLE	
CHECKED								548 POWER CIRCUIT & CONFIGURATION	
DESIGN APPROVAL P.S		FINISH						DRAWING NUMBER HJ 049734 D	
MANF APPROVAL								SHT 1 OF 1 SHTS	



DIMS. IN M.M. APPLY OVER FINISH  
 (EXCEPT FOR PAINT AND LAQUER)

GENERAL TOLERANCE X.X ± 0.4  
 X.XX ± 0.2  
 X.XXX ± 0.1

HOLES < 87 mm  
 -0.02-0.07



KE 0430080

ISS.	MODIFICATION	CP.NO.	DATE	APPROVAL
1	Initial Issue			
2	Up-dating Part Numbers on pages 44,45 and 46. Up-dating Sales & Service Address List.	2739	16.11.89	GDR
3	Corrections and amendments to pages 2, 5, 7 and 29. Drawing HG049968 now issue 3. Up-dating Sales & Service Address List.	3038	8.5.90	GDR
FIRST USED ON		MODIFICATION RECORD 545 Product Manual		
 LITTLEHAMPTON ENGLAND TELEX 87142			DRAWING NUMBER  ZZ049975C	SHT. 1 of 1